

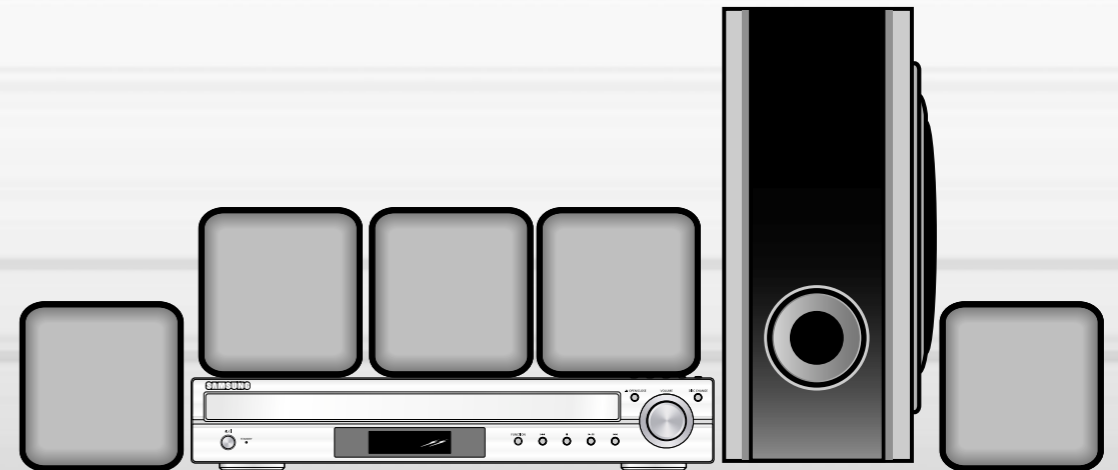

# Home Theater System with 5 Disc DVD Changer HT-P29

THIS APPLIANCE IS MANUFACTURED BY:

## Instruction Manual



# Safety Warnings

**CLASS 1 LASER PRODUCT  
KLASSE 1 LASER PRODUKT  
LUOKAN 1 LASER LAITE  
KLASS 1 LASER APPARAT  
PRODUCTO LASER CLASE 1**

**CAUTION**  
RISK OF ELECTRIC SHOCK.  
DO NOT OPEN

**CAUTION:**  
TO REDUCE THE RISK OF ELECTRIC SHOCK, DO NOT REMOVE REAR COVER. NO USER SERVICEABLE PARTS INSIDE. REFER SERVICING TO QUALIFIED SERVICE PERSONNEL.



This symbol indicates that dangerous voltage which can cause electric shock is present inside this unit.



This symbol alerts you to important operating and maintenance instructions accompanying the unit.

**WARNING:** To reduce the risk of fire or electric shock, do not expose this appliance to rain or moisture.

**CAUTION:** TO PREVENT ELECTRIC SHOCK, MATCH WIDE BLADE OF PLUG TO WIDE SLOT, FULLY INSERT.

## Note to CATV system installer :

This reminder is provided to call the CATV system installer's attention to Section 820-40 of the NEC which provides guidelines for proper grounding and, in particular, specifies that the cable ground shall be connected to the grounding system of the building, as close to the point of cable entry as practical

## CLASS 1 LASER PRODUCT

This Compact Disc player is classified as a CLASS 1 LASER product.

Use of controls, adjustments or performance of procedures other than those specified herein may result in hazardous radiation exposure.

**CAUTION-INVISIBLE LASER RADIATION WHEN OPEN AND INTERLOCKS DEFEATED, AVOID EXPOSURE TO BEAM.**

AH68-01701X

# Precautions

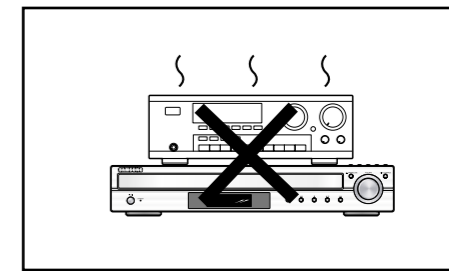
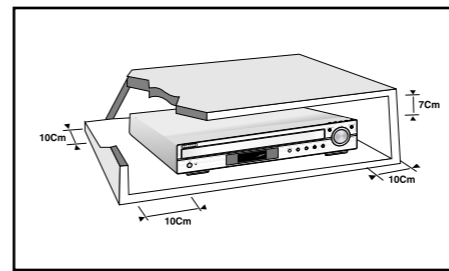

Ensure that the AC power supply in your house complies with the identification sticker located on the back of your player. Install your player horizontally, on a suitable base (furniture), with enough space around it for ventilation (3~4inches). Make sure the ventilation slots are not covered. Do not stack anything on top of the player. Do not place the player on amplifiers or other equipment which may become hot. Before moving the player, ensure the disc tray is empty. This player is designed for continuous use. Switching off the Home Theater to the stand-by mode does not disconnect the electrical supply. In order to disconnect the player completely from the power supply, remove the main plug from the wall outlet, especially when left unused for a long period of time.

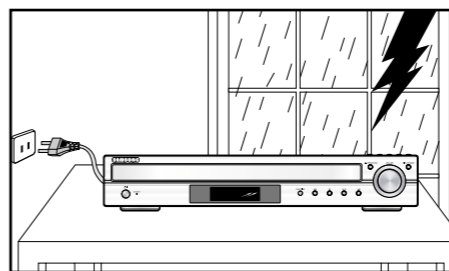

During thunderstorms, disconnect AC main plug from the wall outlet. Voltage peaks due to lightning could damage the unit.

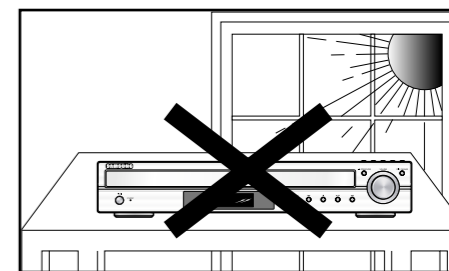

Do not expose the unit to direct sunlight or other heat sources. This could lead to overheating and malfunction of the unit.

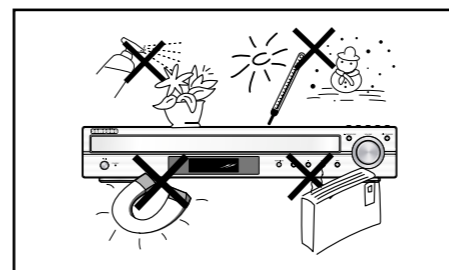

Protect the player from moisture (i.e. vases), and excess heat (e.g. fireplace) or equipment creating strong magnetic or electric fields (i.e. speakers...). Disconnect the power cable from the AC supply if the player malfunctions. Your player is not intended for industrial use.

Use of this product is for personal use only.

Condensation may occur if your player or disc has been stored in cold temperatures.

If transporting the player during the winter, wait approximately 2 hours until the unit has reached room temperature before using.

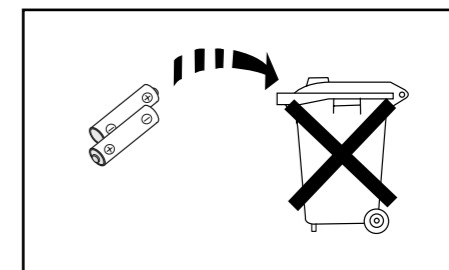

The batteries used with this product contain chemicals that are harmful to the environment.

Do not dispose of batteries in the general household trash.

# Features

## ● Multi-Disc Playback & FM Tuner

The HT-P29 combines the convenience of multi-disc playback capability, including DVD, VCD, CD, MP3-CD, CD-R/RW, and DVD-R/RW, with a sophisticated FM tuner, all in a single player.

## ● Dolby Pro Logic II

Dolby Pro Logic II is a new form of multi-channel audio signal decoding technology that improves upon existing Dolby Pro Logic.

## ● TV Screen Saver Function

The HT-P29 automatically brightens and darkens your TV screen after 3 minutes in the stop mode.  
The HT-P29 automatically switches itself into the power saving mode after 20 minutes in the screen saver mode.

## ● Power Saving Function

The HT-P29 automatically shuts itself off after 20 minutes in the stop mode.

## ● Customized TV Screen Display

The HT-P29 allows you to select your favorite image during JPEG, DVD or VCD playback and set it as your background wallpaper.

# Contents

<b>● PREPARATION</b>	
Safety Warnings.....	1
Precautions.....	2
Features.....	3
Notes on Discs.....	5
<b>● CONNECTIONS</b>	
Description.....	7
Connecting the Speakers.....	11
Connecting the Video Out to TV.....	13
P.SCAN(Progressive Scan) Function.....	14
Connecting External Components.....	15
Connecting the FM Antenna.....	16
Before Using Your Home Theater.....	17
<b>● OPERATION</b>	
Disc Playback.....	19
Selecting a Disc in the Disc changer.....	20
MP3-CD Playback.....	21
To play different file types on the same disc.....	22
JPEG File Playback.....	23
Displaying Disc Information.....	25
Checking the Remaining Time.....	26
Fast/Slow Playback.....	27
Skipping Scenes/Songs.....	28
Repeat Playback.....	29
A-B Repeat Playback.....	30
Step Function.....	31
Angle Function.....	31
Zoom (Screen Enlarge) Function.....	32
EZ VIEW Function.....	32
Selecting Audio/Subtitle Language.....	33
Moving Directly to a Scene/Song.....	34
Using Disc Menu.....	35
Using the Title Menu.....	36
<b>● SETUP</b>	
Setting the Language.....	37
Setting TV Screen type.....	39
Setting Parental Controls (Rating Level).....	41
Setting the Password.....	42
Setting the Wallpaper.....	43
Setting the Speaker Mode.....	45
Setting the Test Tone.....	46
Setting the Delay Time.....	47
Setting the Audio.....	49
Setting the DRC (Dynamic Range Compression).....	51
AV SYNC Setup.....	52
Dolby Pro Logic II Mode.....	53
Dolby Pro Logic II Effect.....	54
<b>● RADIO OPERATION</b>	
Listening to Radio.....	55
Presetting Stations.....	56
<b>● MISCELLANEOUS</b>	
Convenient Functions.....	57
Operating a TV with the Remote Control.....	59
Before Calling for Service.....	61
Cautions on Handling and Storing Discs.....	63
Language Code List.....	64
Specifications.....	65
WARRANTY.....	66



**DVD (Digital Versatile Disc)** offers fantastic audio and video, thanks to Dolby Digital surround sound and MPEG-2 video compression technology. Now you can enjoy these realistic effects in the home, as if you were in a movie theater or concert hall.



Home Theaters and the discs are coded by region. These regional codes must match in order for the disc to play. If the codes do not match, the disc will not play.

The Region Number for this player is given on the rear panel of the player. (Your Home Theater will only play DVDs that are labeled with identical region codes.)

## Playable Discs

Disc Type	Mark (Logo)	Recorded Signals	Disc Size	Max. Playing Time
DVD-VIDEO		Video	12cm	Approx. 240 min. (single-sided) Approx. 480 min. (double-sided)
			8cm	Approx. 80 min. (single-sided) Approx. 160 min. (double-sided)
AUDIO-CD		Audio	12cm	74 min.
			8cm	20 min.

## Do not use the following types of disc!

- LD, CD-G, CD-I, CD-ROM and DVD-ROM discs cannot be played on this player. If such discs are played, a "WRONG DISC FORMAT" message appears on the TV screen.
- DVD discs purchased abroad may not play on this player. If such discs are played, a "WRONG REGION CODE" message appears on the TV screen.

## Copy Protection

- Many DVD discs are encoded with copy protection. Because of this, you should only connect your Home Theater directly to your TV, not to a VCR. Connecting to a VCR results in a distorted picture from copy-protected DVD discs.
- This product incorporates copyright protection technology that is protected by methods claims of certain U.S. patents and other intellectual property rights owned by Macrovision Corporation and other rights owners. Use of this copyright protection technology must be authorized by Macrovision Corporation, and is intended for home and other limited viewing uses only unless otherwise authorized by Macrovision Corporation. Reverse engineering or disassembly is prohibited.

## Disc Recording Format

### CD-R Discs

- Some CD-R discs may not be playable depending on the disc recording device (CD-Recorder or PC) and the condition of the disc.
- Use a 650MB/74 minute CD-R. Other CD-R media, may not be playable.
- Some CD-RW (Rewritable) media, may not be playable.
- Only CD-Rs that are properly "closed" can be fully played. If the session is closed but the disc is left open, you may not be able to fully play the disc.

### CD-R MP3 Discs

- Only CD-R discs with MP3 files in ISO 9660 or Joliet format can be played.
- MP3 file names should be 8 characters or less in length and contain no blank spaces or special characters (. / = +).
- Use discs recorded with a compression/decompression data rate greater than 128Kbps.
- Only files with the ".mp3" and ".MP3" extensions can be played.
- Only a consecutively written Multisession disc can be played. If there is a blank segment in the Multisession disc, the disc can be played only up to the blank segment.
- If the disc is not closed, it will take longer to begin playback and not all of the recorded files may be played.
- For files encoded in Variable Bit Rate (VBR) format, i.e. files encoded in both low bit rate and high bit rate (e.g., 32Kbps ~ 320Kbps), the sound may skip during playback.
- A maximum of 500 tracks can be played per CD.
- A maximum of 300 folders can be played per CD.

### CD-R JPEG Discs

- Only files with the ".jpeg" and ".JPEG" extensions can be played.
- If the disc is not closed, it will take longer to start playing and not all of the recorded files may be played.
- Only CD-R discs with JPEG files in ISO 9660 or Joliet format can be played.
- JPEG file names should be 8 characters or less in length and contain no blank spaces or special characters (. / = +).
- Only a consecutively written multisession disc can be played. If there is a blank segment in the multisession disc, the disc can be played only up to the blank segment.
- A maximum of 9,999 images can be stored on a single CD.
- When playing a Kodak/Fuji Picture CD, only the JPEG files in the picture folder can be played.
- Picture discs other than Kodak/Fuji Picture CDs may take longer to start playing or may not play at all.

# Description

## —Front Panel—

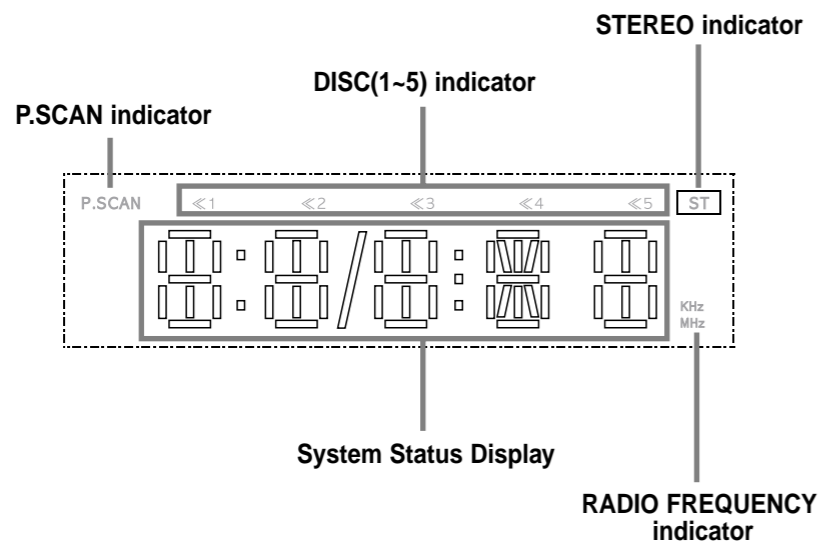
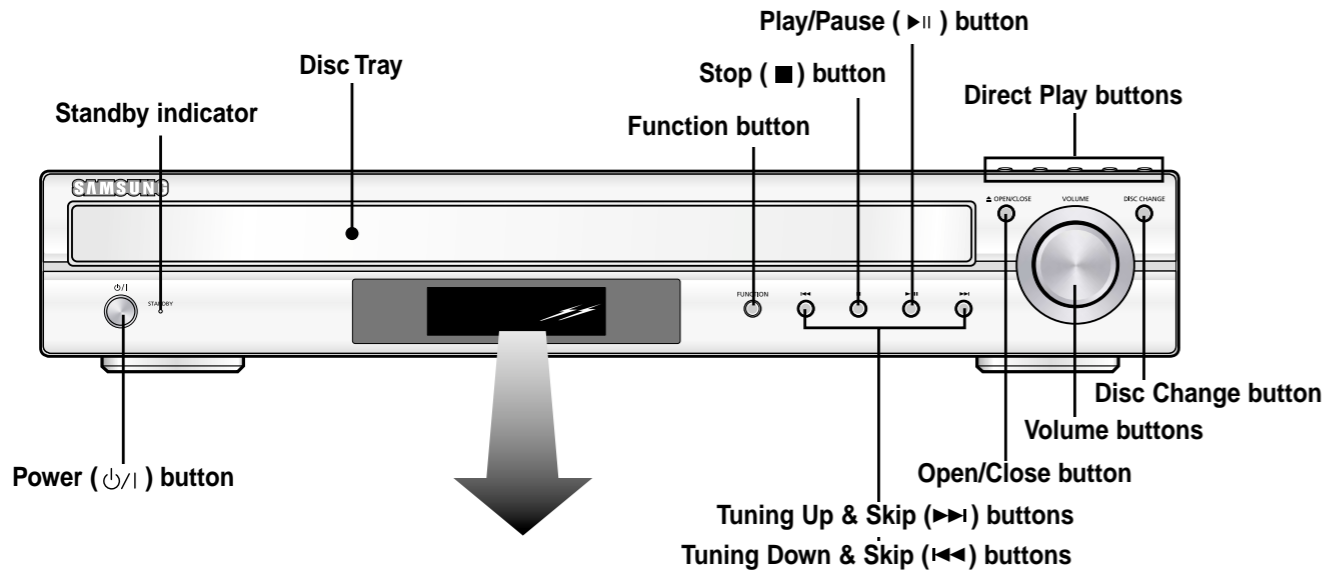

## —Rear Panel—

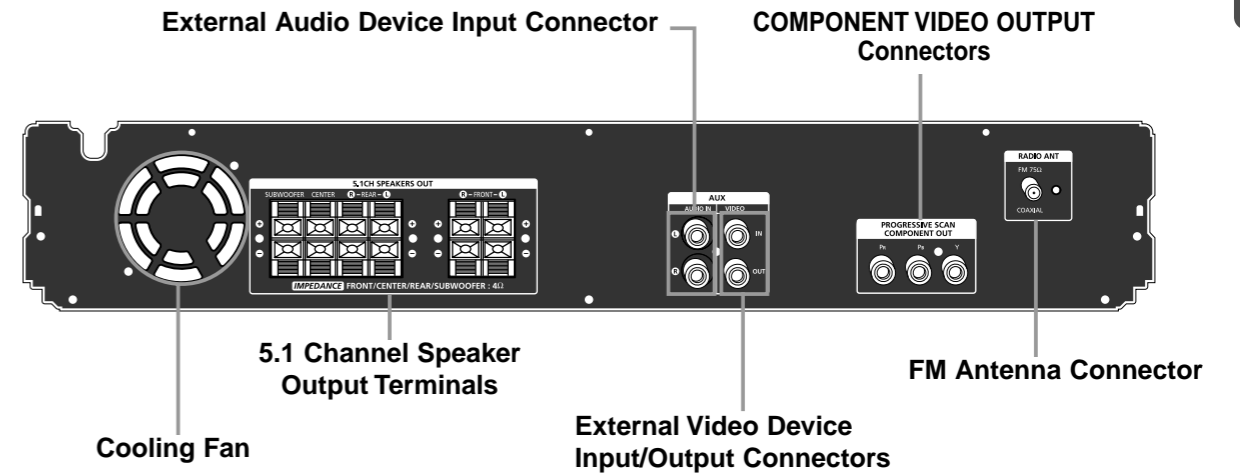

## Accessories

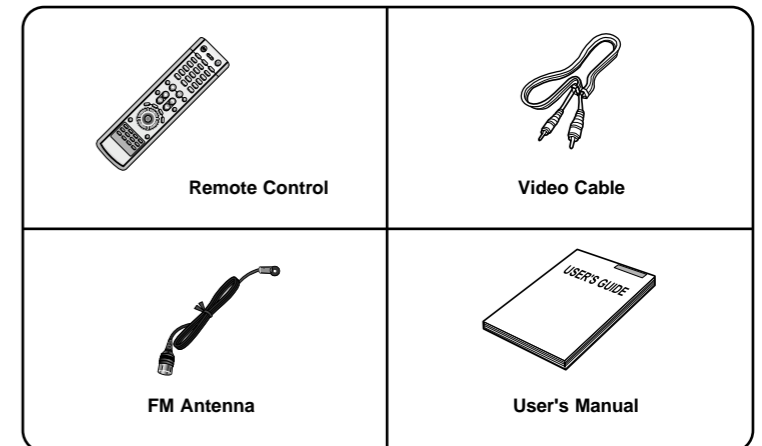

## —Remote Control—

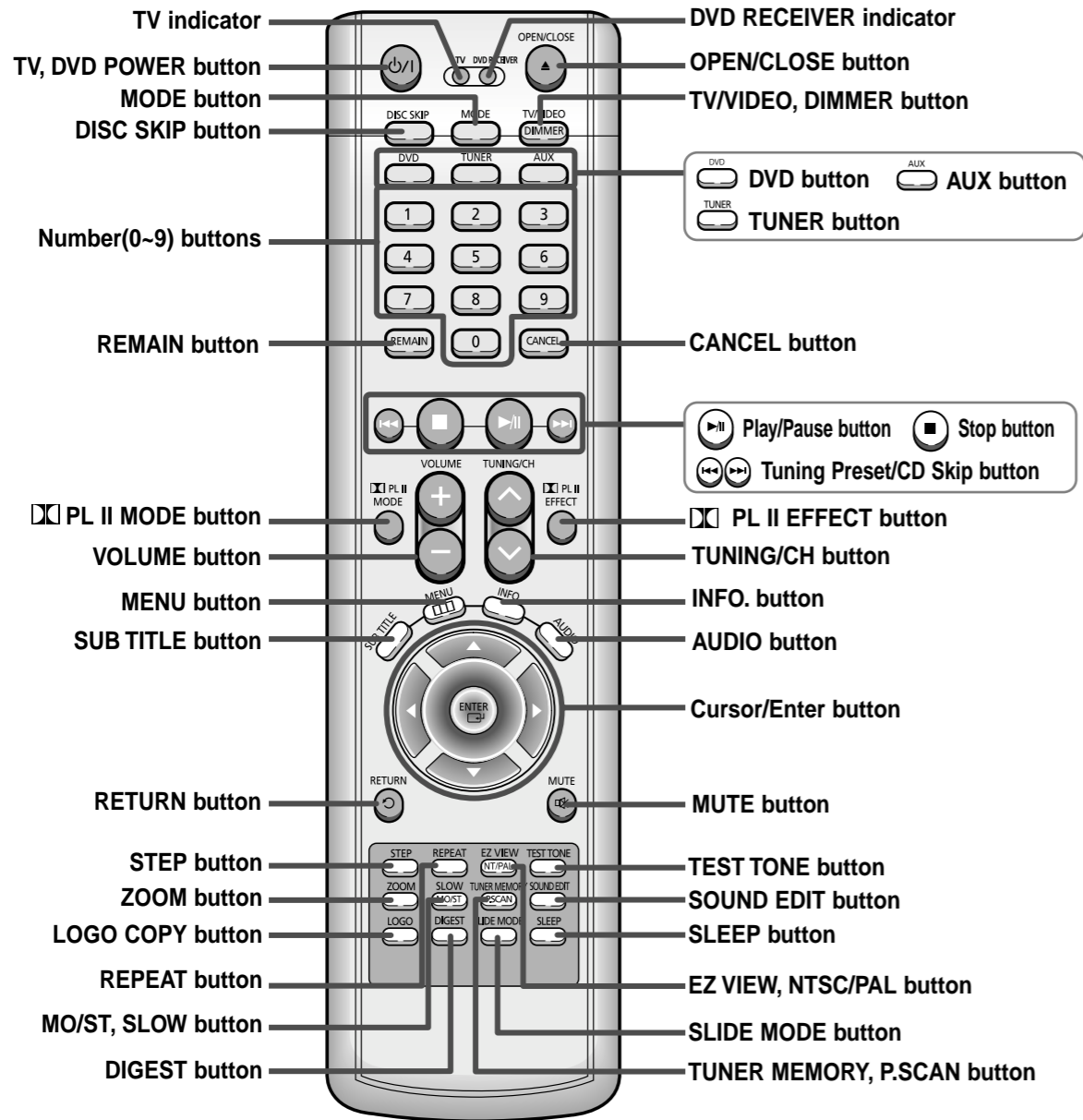

### Insert Remote Batteries

- 1** Remove the battery cover on the back of the remote by pressing down and sliding the cover in the direction of the arrow.
- 2** Insert two 1.5V AAA batteries, paying attention to the correct polarities (+ and -).
- 3** Replace the battery cover.

- Caution** Follow these precautions to avoid leaking or cracking cells:
- Place batteries in the remote control so they match the polarity:(+) to (+)and (-)to (-).
  - Use the correct type of batteries.Batteries that look similar may differ in voltage.
  - Always replace both batteries at the same time.
  - Do not expose batteries to heat or flame.

### Range of Operation of the Remote Control

The remote control can be used up to approximately 23 feet/7 meters in a straight line. It can also be operated at a horizontal angle of up to 30° from the remote control sensor.

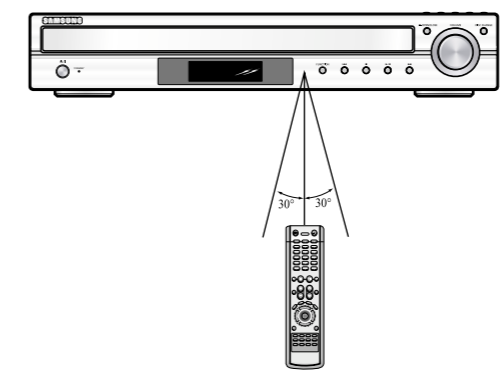

# Connecting the Speakers

Before moving or installing the product, be sure to turn off the power and disconnect the power cord.

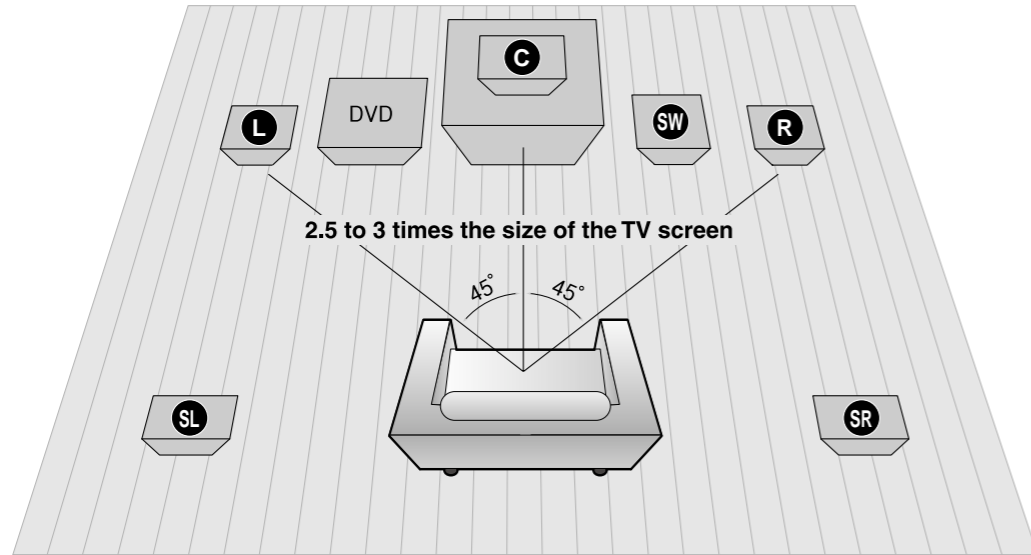

## Position of the Home Theater

- Place it on a stand, cabinet shelf, or under the TV stand.

## Selecting the Listening Position

The listening position should be located about 2.5 to 3 times the distance of the TV's screen size away from the TV. Example: For 32" TVs 2~2.4m (6~8 feet)  
For 55" TVs 3.5~4m (11~13 feet)

## Front Speakers L R

- Place these speakers in front of your listening position, facing inwards (about 45°) toward you.
- Place the speakers so that their tweeters will be at the same height as your ear.
- Align the front face of the front speakers with the front face of the center speaker or place them slightly in front of the center speakers.

## Center Speaker C

- It is best to install it at the same height as the front speakers.
- You can also install it directly over or under the TV.

## Rear Speakers SL SR

- Place these speakers behind your listening position.
- If there isn't enough room, place these speakers so they face each other.
- Place them about 60 to 90cm (2 to 3feet) above your ear, facing slightly downward.

\* Unlike the front and center speakers, the rear speakers are used to handle mainly sound effects and sound will not come from them all the time.

## Subwoofer SW

- The position of the subwoofer is not so critical. Place it anywhere you like.

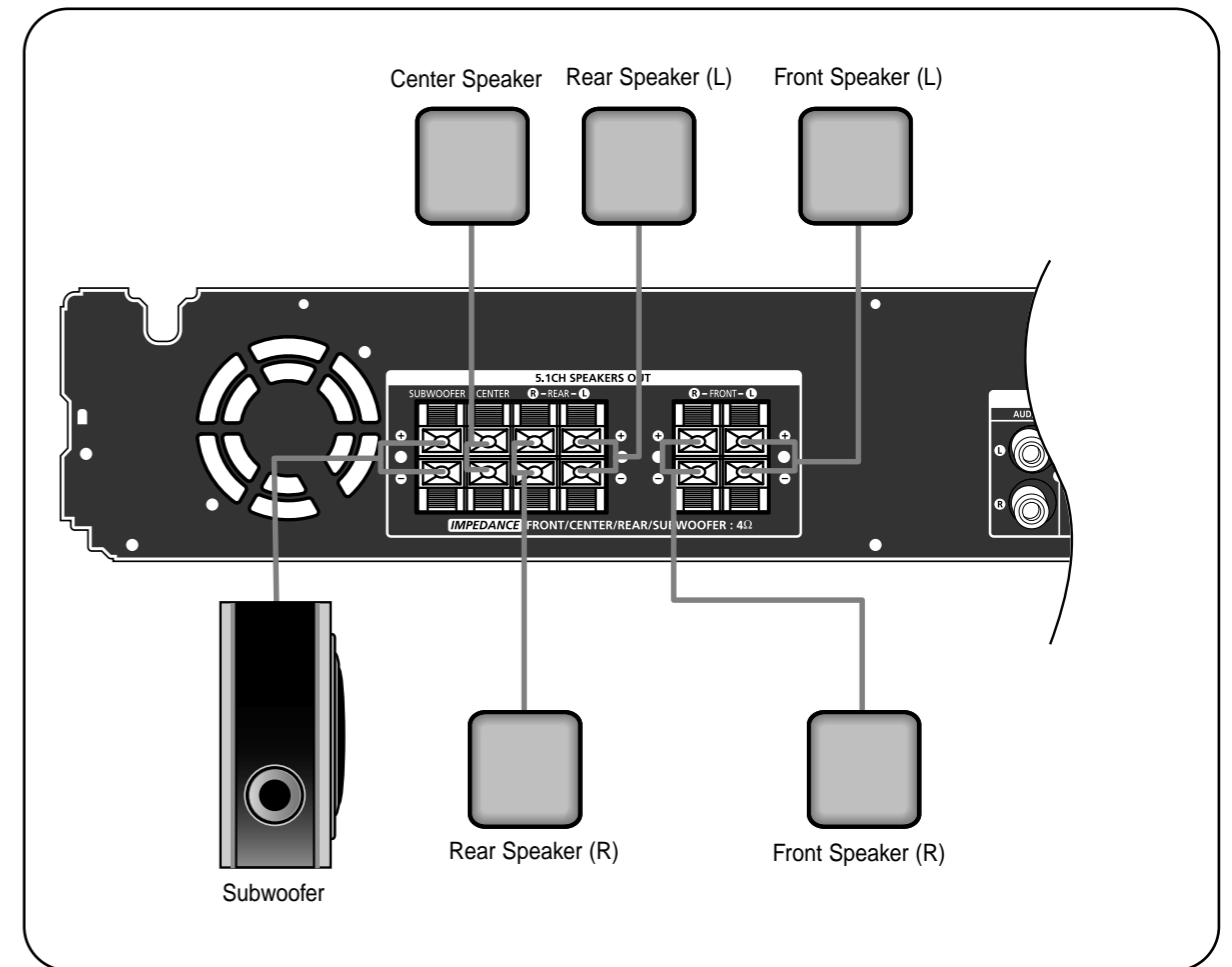

1 Press and hold the terminal tab.

2 Insert the speaker cord.

3 Release your finger.

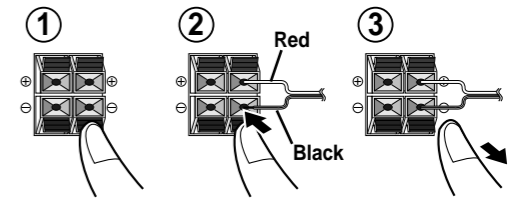

**Note** • Connect the red cord to the red (+) terminal and the black cord to the black (-) terminal.

# Connecting the Video Out to TV

Choose one of the two methods for connecting to a TV.

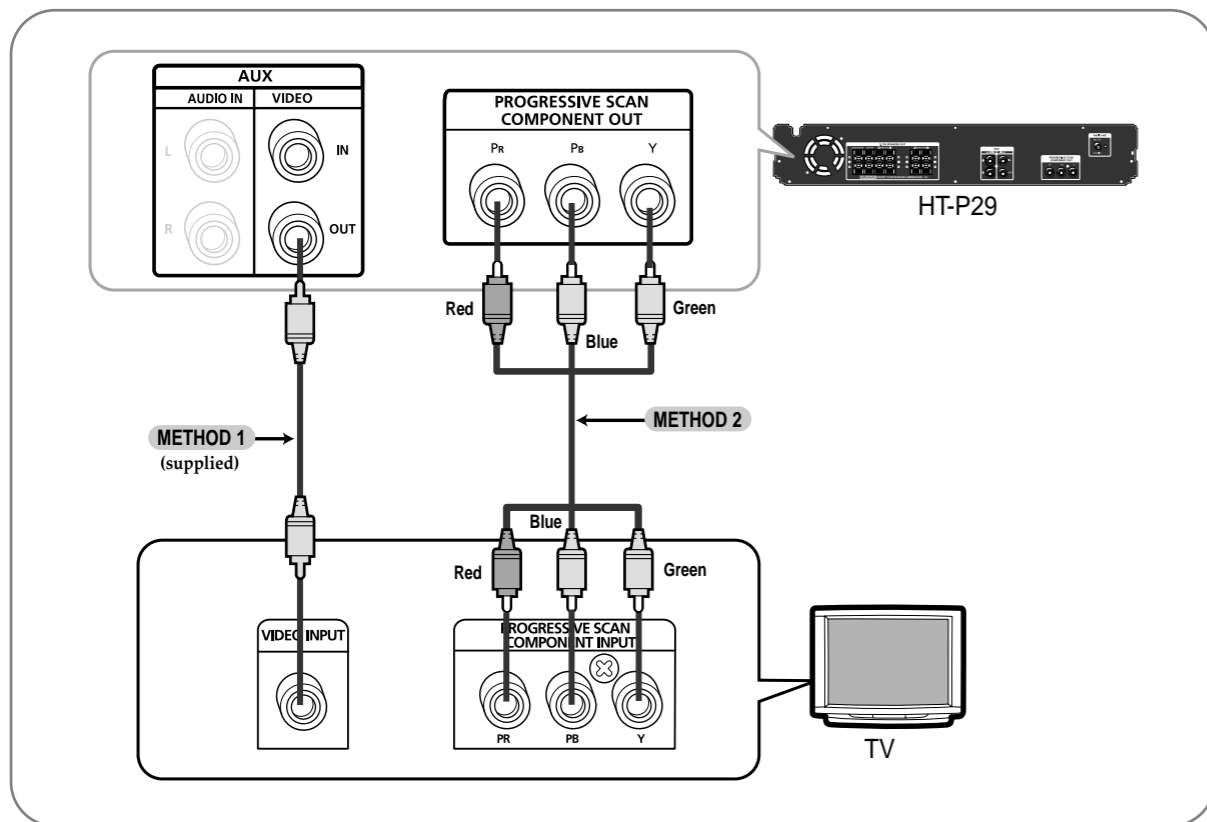

## METHOD 1 Composite Video ..... (Good Quality)

- Connect the supplied video cable from the VIDEO OUT jack on the back panel of the system to the VIDEO IN jack on your TV.

## METHOD 2 Component ..... (Best Quality)

- If your television is equipped with Component Video inputs, connect a component video cable (not supplied) from the Pr, Pb and Y jacks on the back panel of the system to the corresponding jacks on your TV.

- Note**
- After connecting the Home Theater to your TV, set the input on your TV so the signal from the Home theater appears on your TV screen.
  - When the Progressive scan mode is selected, the VIDEO output do not feed any signal.

# P.SCAN(Progressive Scan) Function

ENG

Unlike regular Interlace Scan, in which two fields of picture information alternate to create the entire picture (odd scan lines, then even scan lines), Progressive Scan uses one field of information (all lines displayed in one pass) to create a clear and detailed picture without visible scan lines.

- 1 Press STOP button.**
  - When disc is played back, press the **STOP** button twice so that "STOP", appears on the display.
- 2 Press and hold P.SCAN button on the remote control for over 5 seconds.**
  - Pressing and holding the button for over 5 seconds will select "Progressive Scan" and "Interlace Scan" alternately.
  - When you select P.SCAN, "P.SCAN" will appear on the display.

## What is Progressive (or Non-Interlaced) Scanning?

Interlaced Scan (1 FRAME = 2 FIELDS)	Progressive Scan (FULL FRAME)
<p>In interlaced-scan video, a frame consists of two interlaced fields (odd and even), where each field contains every other horizontal line in the frame. The odd field of alternating lines is displayed first, and then the even field is displayed to fill in the alternating gaps left by the odd field to form a single frame. One frame, displayed every 1/30th of a second, contains two interlaced fields, thus a total of 60 fields are displayed every 1/60th of a second. The interlaced scanning method is intended for capturing a still object.</p>	<p>The progressive scanning method scans one full frame of video consecutively down the screen, line by line. An entire image is drawn at one time, as opposed to the interlaced scanning process by which a video image is drawn in a series of passes. The progressive scanning method is desirable for dealing with moving objects.</p>

- Note**
- This function works only on TVs equipped with component video inputs (Y, Pr, Pb) that support Progressive Video. (It does not work on TVs with conventional component inputs, i.e., non-progressive scan TVs.)
  - Depending on the brand and model of your TV, this function may not work.

CONNECTIONS



# Connecting External Components

Example: Analog signal components such as a VCR or TV.

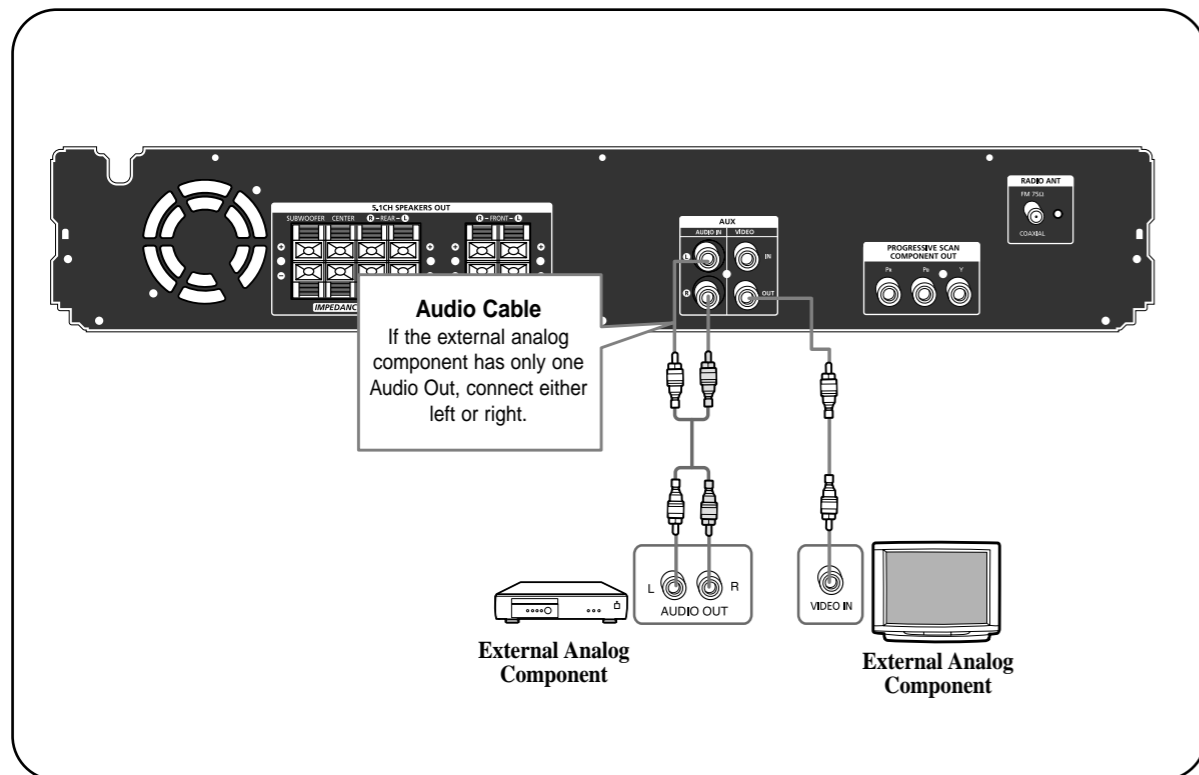

- 1 Connect Video Out on the Home Theater to Video In on your TV.
- 2 Connect Audio In on the Home Theater to Audio Out on the external analog component.
  - Be sure to match connector colors.
- 3 Press **AUX** on the remote control or main unit to select 'AUX'.
  - 'AUX' appears in the display.



# Connecting the FM Antenna

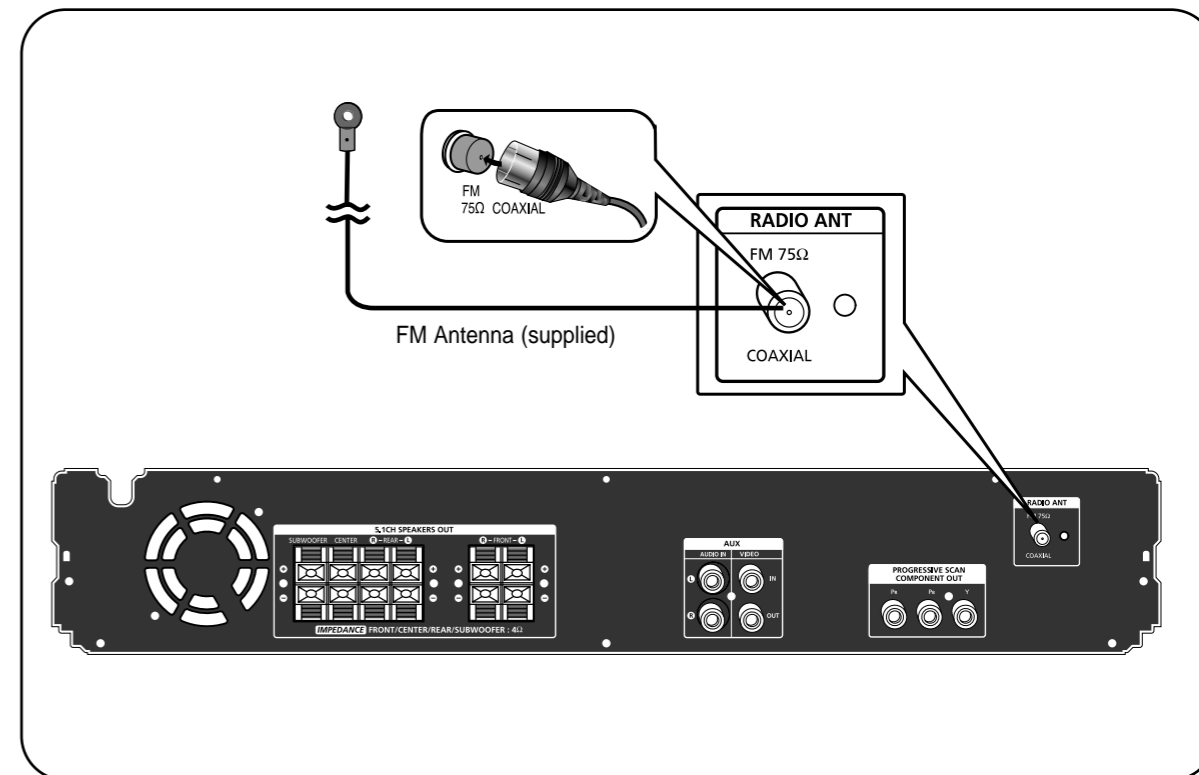

- 1 Connect the FM antenna supplied to the FM 75Ω COAXIAL terminal.
- 2 Slowly move the antenna wire around until you find a location where reception is good, then fasten it to a wall or other rigid surface.

## Cooling Fan

The cooling fan supplies cool air to the unit to prevent overheating.



Please observe the following cautions for your safety.

- Make sure the unit is well-ventilated. If the unit has poor ventilation, the temperature inside the unit could rise and may damage it.
- Do not obstruct the cooling fan or ventilation holes. (If the cooling fan or ventilation holes are covered with a newspaper or cloth, heat may build up inside the unit and fire may result.)

# Before Using Your Home Theater

Your Home Theater is capable of playing DVD, CD, MP3 and JPEG discs. Depending on the disc you are using, these instructions may vary slightly. Read the instructions carefully before using.

## To Operate your Samsung TV and the Home Theater with the HT-P29's Remote Control

- 1 Plug the main unit's power cord into the AC power supply.

- 2 Press **MODE** button until the TV indicator lights.

- 3 Press the **POWER** button to turn on the TV.

- 4 Press **TV/VIDEO** button to select VIDEO mode.

- 5 Press the **MODE** button until the DVD RECEIVER indicator lights.

- 6 Press **FUNCTION** button on the main unit or DVD on the remote to select DVD/CD mode.

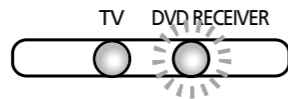
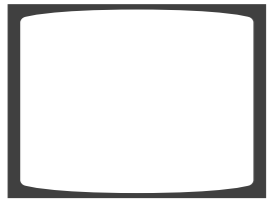
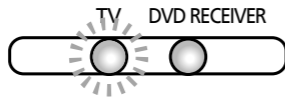

### Note

- Buttons Enabled for TV Operation: POWER, CHANNEL, VOLUME, TV/VIDEO and Numeric (0-9) buttons.
- By default, the remote control is set to work with Samsung TVs. See page 59 for more information remote control operation with other manufacturer's TVs.

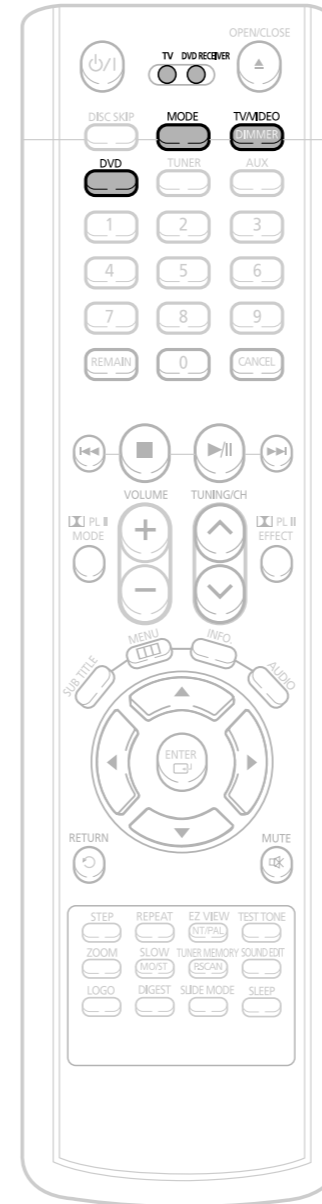

## Disc terminology

### Titles and chapters (DVD-VIDEO)

- DVD-video is divided into several large sections called "titles" and smaller sections called "chapters". Numbers are allotted to these sections. These numbers are called "title numbers" and "chapter numbers".

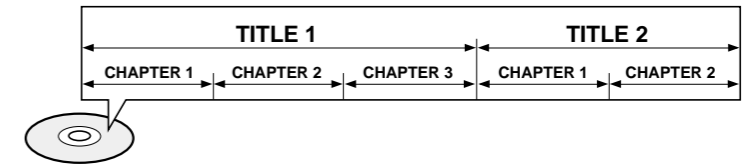

### Tracks (Video and music CDs)

- Video and music CDs are divided into sections called "tracks". Numbers are allotted to these sections. These numbers are called "track numbers".

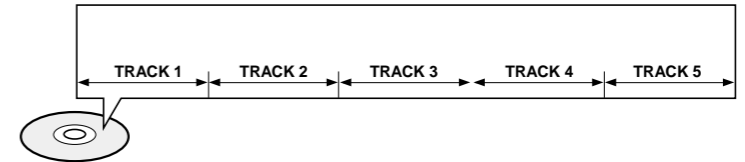

### Note

- In this manual, the instructions marked with "DVD (  )" are applicable to DVD-VIDEO, and DVD-R/RW discs. Where a particular DVD type is mentioned, it is indicated separately.
- Depending on the content of the disc, the initial screen may appear different.

# Disc Playback

**1** Press **OPEN/CLOSE** button to open the disc tray.

**2** Load a disc.  
• Place a disc gently into the tray with the disc's label facing up.

**3** Press **DISC SKIP** button.  
• Rotate the carousel tray so you can load the third, fourth, and fifth discs.

**4** Close the compartment by pressing the **OPEN/CLOSE** button again.

DVD VCD CD

• Playback starts automatically.

**Note** • Depending on the content of the disc, the initial screen may appear different.

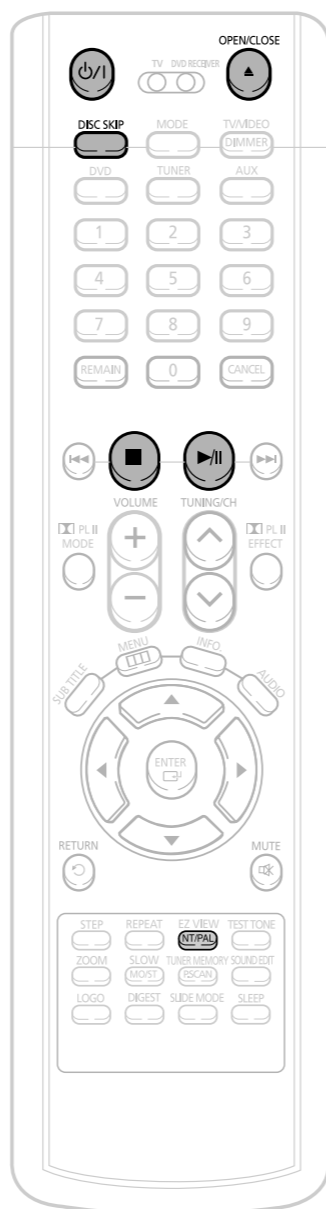

# Selecting a Disc in the Disc changer

ENG

The DVD/CD function is automatically selected when Disc Skip is pushed.

To select a specific disc, press the corresponding **DIRECT PLAY (1, 2, 3, 4, 5)** buttons on the front panel or **DISC SKIP** on the remote control, until the required disc indicator flashes.

• If the disc selected is not loaded, the next disc is played automatically.

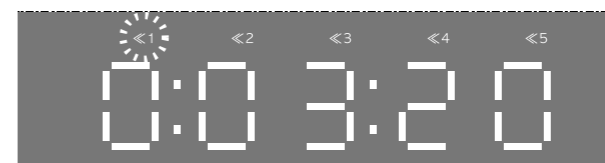

To stop playback, press **STOP** during playback.

- If pressed once, "PRESS PLAY" is displayed and the stop position will be stored in memory. If **PLAY/PAUSE (▶/||)** button or **ENTER** button is pressed, playback resumes from the stop position. (This function works only with DVDs.)
- If pressed twice, "STOP" is displayed, and if **PLAY/PAUSE (▶/||)** button is pressed, playback starts from the beginning.

To temporarily pause playback, press **PLAY/PAUSE** during playback.

- To resume playback, press **PLAY/PAUSE (▶/||)** button again.

Selecting the Video Format

Turn off the main unit and then press **NT/PAL**.

- By default, the video format is set to "NTSC".
- Each time the button is pressed, the video format switches between "NTSC" and "PAL".
- Each country has a different video format standard.
- For normal playback, the video format of the disc must be the same as the video format of your TV.

OPERATION

# MP3-CD Playback

Data CDs (CD-ROM, CD-R, CD-RW) encoded in MP3/WMA format can be played.

**1** Press the **OPEN/CLOSE** button to open the disc tray, and then load the MP3/WMA disc.

- The MP3/WMA menu screen will appear and playback will start.
- The appearance of the menu depends on the MP3/WMA disc.

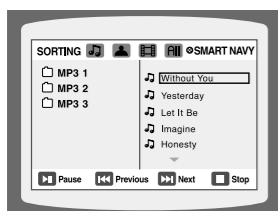

**2** In Stop mode, use **◀▶▲▼** to select the album, and then press the **ENTER** button.

- User **▲▼** to select the track.

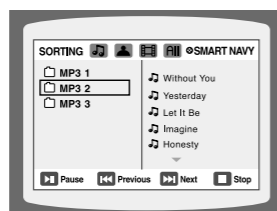

**3** To change the album, use **◀▶▲▼** to select another album and then press the **ENTER** button.

- To select another album and track, repeat Steps 2 and 3 above.

**4** Press the **STOP** button to stop playback.

## Note

- Depending on the recording mode, some MP3-CD/WMA files may not play.
- Table of contents of a MP3-CD/WMA varies depending on the MP3-CD/WMA track format recorded on the disc.
- MP3 file support: MPEG1 LAYER3 (BITRATE : 128KBPS~320KBPS , SAMPLING FREQ.: 32K/44.1K/48KHz)

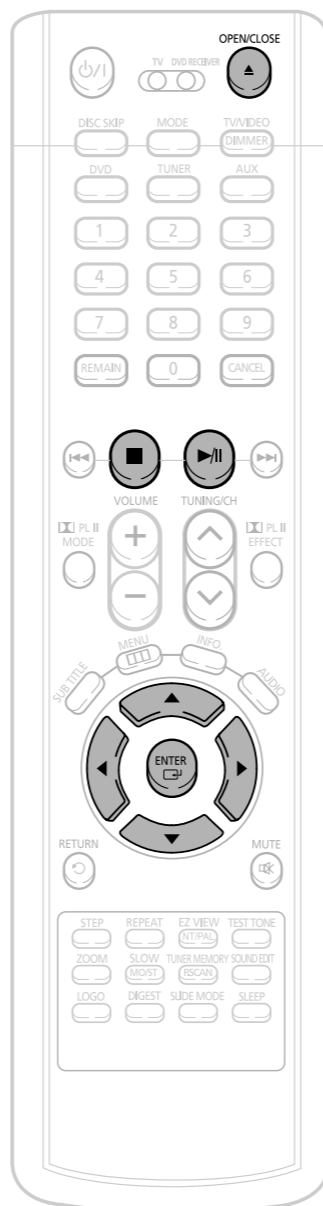

# To play different file types on the same disc

ENG

**1** In Stop mode, press the **◀▶▲▼** buttons and select a desired icon from the top part of the menu.

- To play music files only, select the **🎵** Icon.
- To play image files only, select the **👤** Icon.
- To play movie files only, select the **🎬** Icon.
- To select all files, select the **All** Icon.

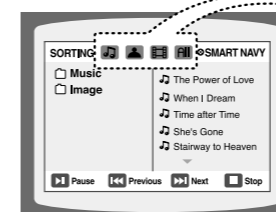

- **🎵** • Music File Icon
- **👤** • Image File Icon
- **🎬** • Movie File Icon
- **All** • All File Icon

**2** Select the desired file and then press the **ENTER** button. The file will play.

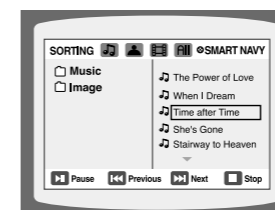

## Note

- This product does not support DivX, AVI and WMV format files and no icon will appear on the TV screen. (However, MPG format file is supported.)

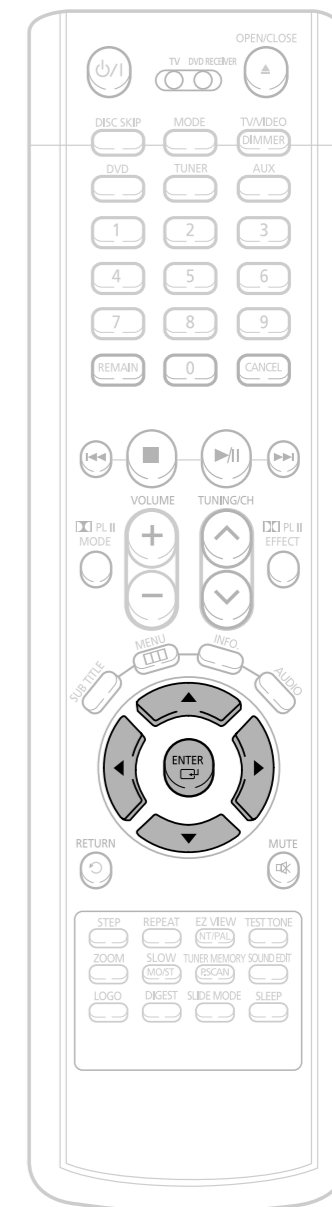

OPERATION

# JPEG File Playback JPEG

Images captured with a digital camera or camcorder, or JPEG files on a PC can be stored on a CD and then played back with this Home Theater.

## Slide Mode

**1** Place the JPEG disc on the disc tray.

**2** Press the **OPEN/CLOSE** button.

- Choose the appropriate JPEG disc in the tray.

**3** Press **SLIDE MODE** button.

- Playback starts automatically.
- Each time the button is pressed, the image makes the transition as follows:

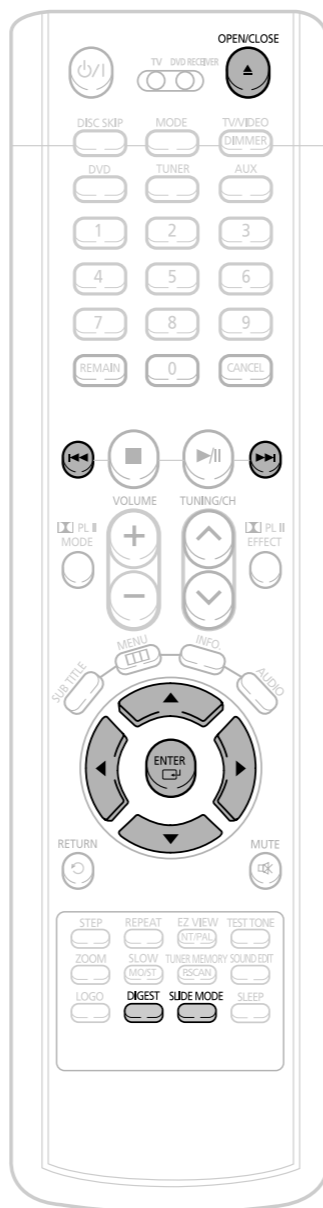
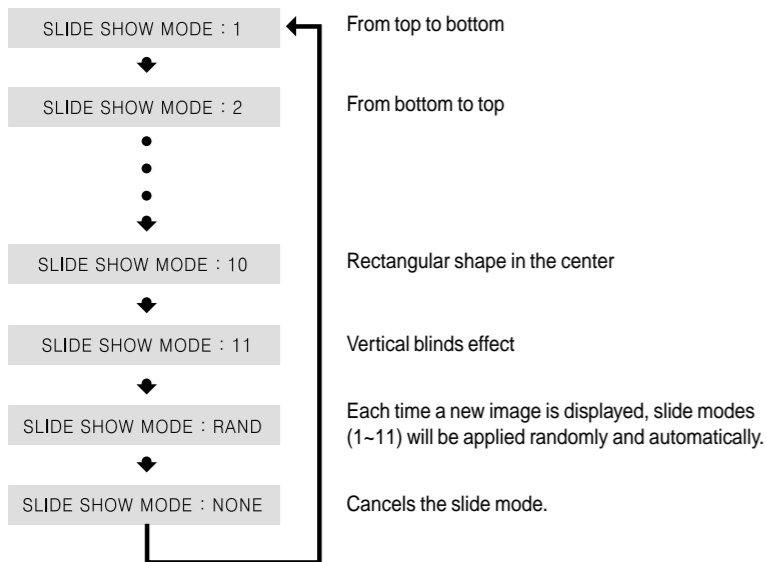

Press **◀◀▶▶** to skip to the next slide.

- Each time the button is pressed, the slide moves backward or forward.

## Digest Function

You can view 9 JPEG images on the TV screen.

**1** Press **DIGEST** button during playback.

- JPEG files will be shown in 9 windows.



**2** Press Cursor **▲, ▼, ◀, ▶** buttons to select the desired image and then press **ENTER** button.

- The selected image is played for 5 seconds before moving to the next image.



To view the previous or next image with 9 windows, press **◀◀▶▶**.

## Rotate/Flip Function

Press Cursor **▲, ▼, ◀, ▶** buttons during playback.

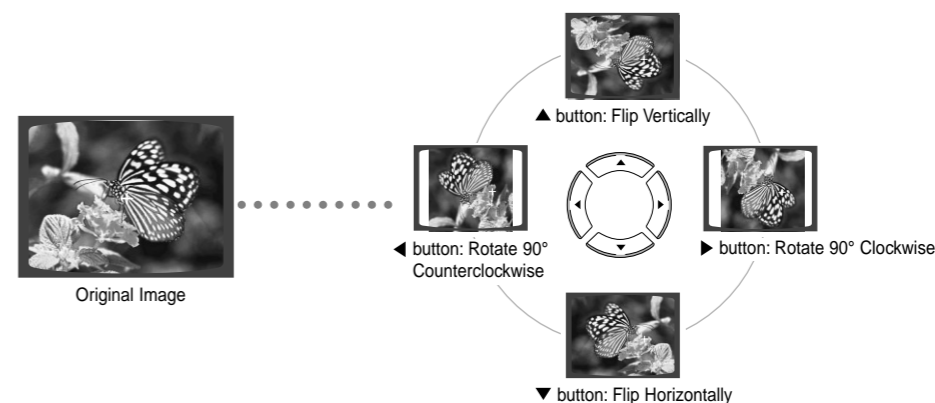

### JPEG limitation

The maximum resolution is 5120 x 3840 (or 19.0 MPixel) for baseline images, and 2048 x 1536 (3.0 MPixel) for progressive images. There is no file size limitation.

Progressive JPEG images — those that appear gradually as the image is being downloaded.

# Displaying Disc Information

You can view disc playback information on the TV screen.

## Press INFO button.

- Each time the button is pressed, the display changes as follows:

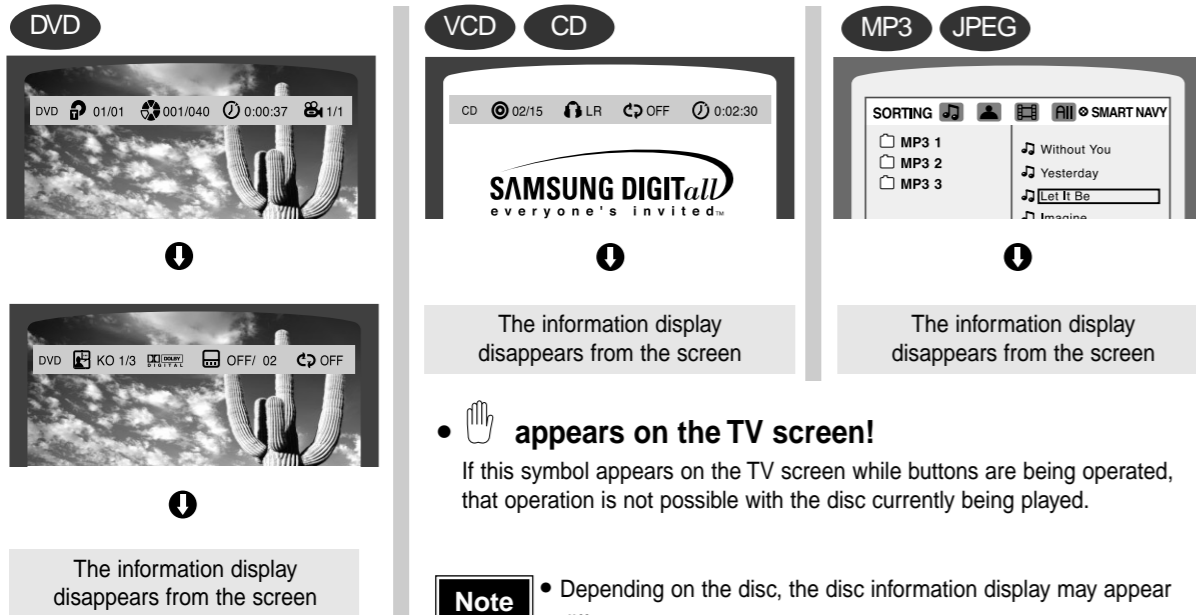

- Note**
- Depending on the disc, the disc information display may appear different.
  - Depending on the disc, you can also select DOLBY DIGITAL, or PRO LOGIC.

## Screen Display

DVD DVD display	TITLE display	ELAPSED TIME display	LR STEREO (L/R) display
VCD VCD display	CHAPTER display	REPEAT PLAYBACK display	DOLBY DIGITAL DOLBY DIGITAL display
CD CD display	TRACK (FILE) display	AUDIO LANGUAGE display	ANGLE display
MP3 MP3 CD display	SUBTITLE display		

# Checking the Remaining Time

## Press the REMAIN button.

- For checking the total and remaining time of a title or chapter being played.

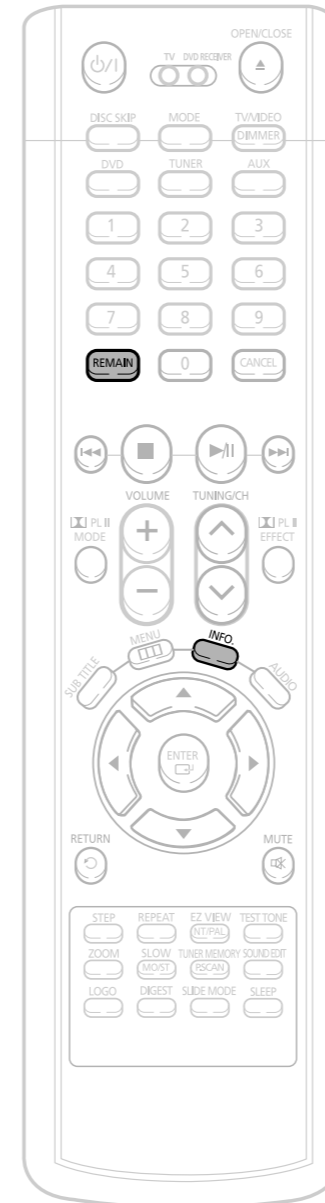

## Each time the REMAIN button is pressed

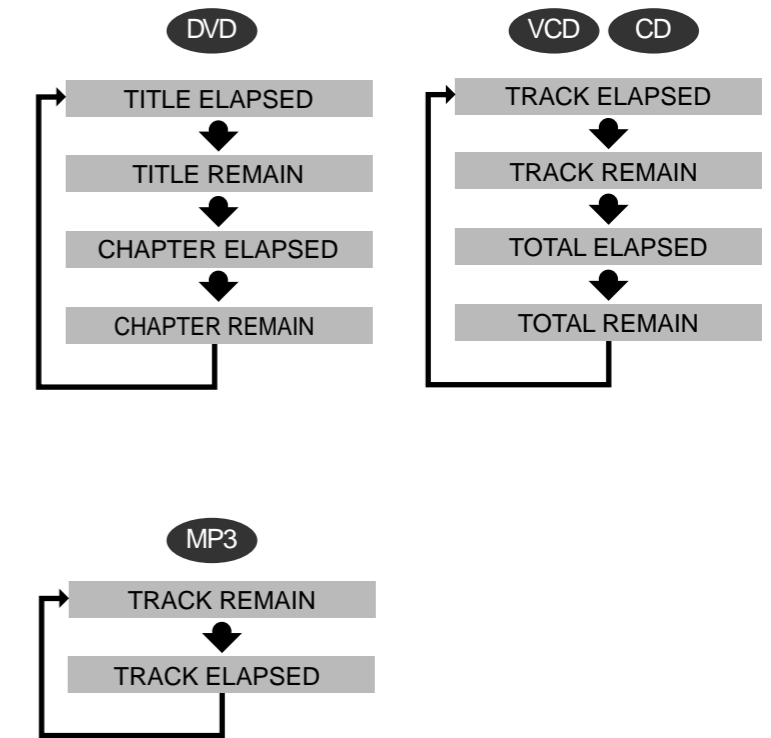

# Fast/Slow Playback

## Fast Playback

DVD VCD CD MP3

Press and hold **⏮** or **⏭**.

- Each time the button is held down during playback, the playback speed changes as follows:

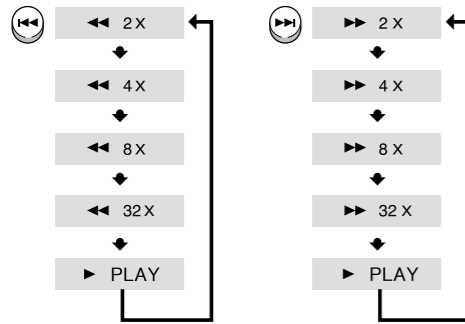

## Slow Playback

Press **SLOW** button.

- Each time the button is pressed during playback, the playback speed changes as follows:

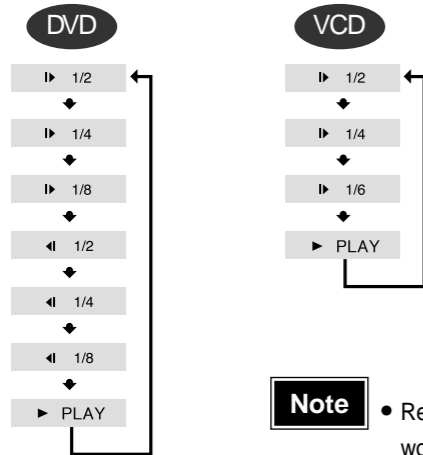

**Note**

- Reverse slow playback does not work with VCD.

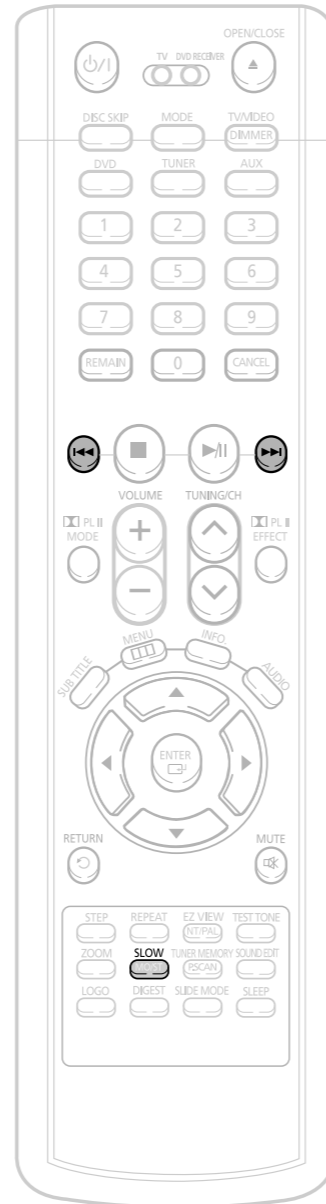

# Skipping Scenes/Songs

Briefly press **⏮** or **⏭**.

- Each time the button is pressed briefly during playback, the previous or next chapter, track, or directory (file) will be played.
- You cannot skip chapters consecutively.



- When watching a VCD with a track longer than 15 minutes, each time **⏮** or **⏭** is pressed, playback will skip back or forward 5 minutes.

# Repeat Playback

Repeat playback allows you to repeatedly play a chapter, title, track (song), or directory (MP3 file).

DVD VCD CD MP3 JPEG

Press **REPEAT** button.

- Each time the button is pressed during playback, the repeat playback mode changes as follows:

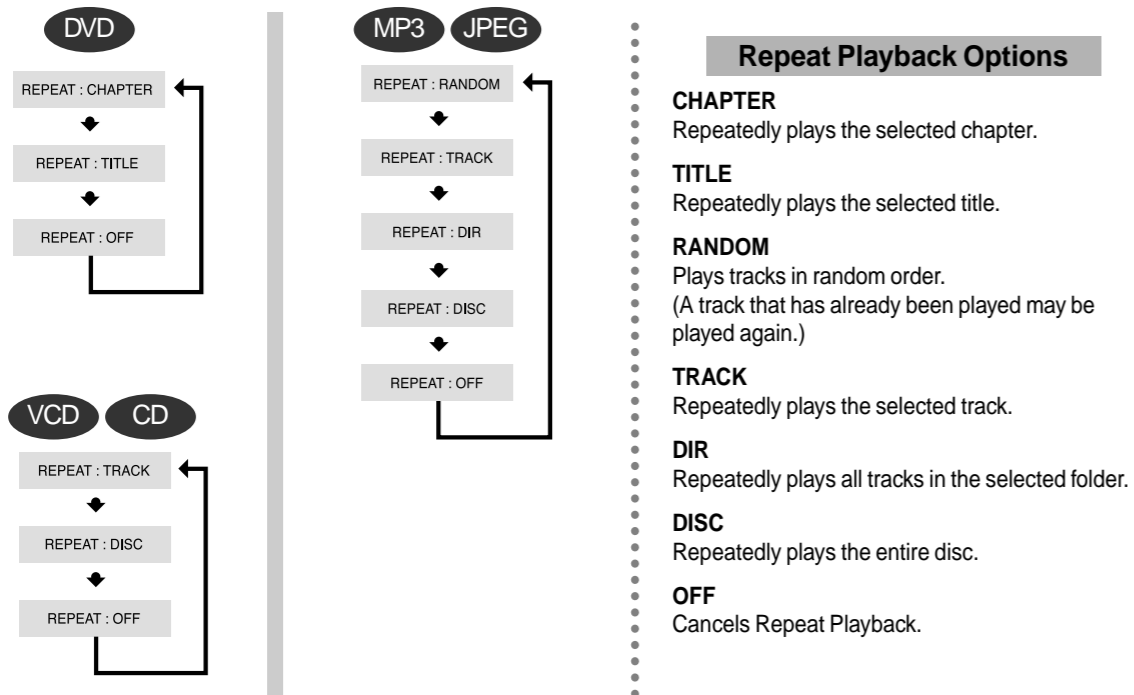

## Note

- Repeat playback operation is not possible with version 2.0 VCD discs if PBC is turned on. To use Repeat Playback on a VCD with PBC, you should set the PBC to OFF in the disc menu. (See page 35.)

## To Select a Repeat Playback Mode in the Disc Information Screen

- Press **INFO** button twice.
- Press Cursor **▶** button to move to REPEAT PLAYBACK (↻) display.
- Press Cursor **▼** button to select the desired Repeat Playback mode.
- Press **ENTER** button.

\* For MP3 and JPEG discs, you cannot select Repeat Play from the information display screen.

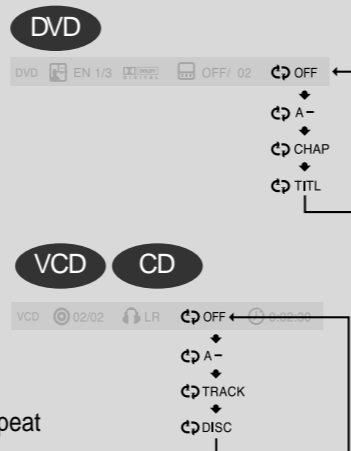

# A-B Repeat Playback

You can repetitively play back a designated section of a DVD.

DVD VCD CD

- Press **INFO** button twice.

- For a VCD or CD, press **INFO** button once.

DVD EN 1/3 OFF/ 02 ↻ OFF

- Press Cursor **▶** button to move to REPEAT PLAYBACK (↻) display.

DVD EN 1/3 OFF/ 02 ↻ OFF

- Press Cursor **▲**, **▼** buttons to select 'A-' and then press **ENTER** button at the beginning of the desired segment.

- When **ENTER** button is pressed, the selected position will be stored in memory.

DVD EN 1/3 OFF/ 02 ↻ A-

DVD EN 1/3 OFF/ 02 ↻ A-?

REPEAT : A-

- Press **ENTER** button at the end of the desired segment.

- The specified segment will be played repeatedly.

DVD EN 1/3 OFF/ 02 ↻ A-B

REPEAT : A-B

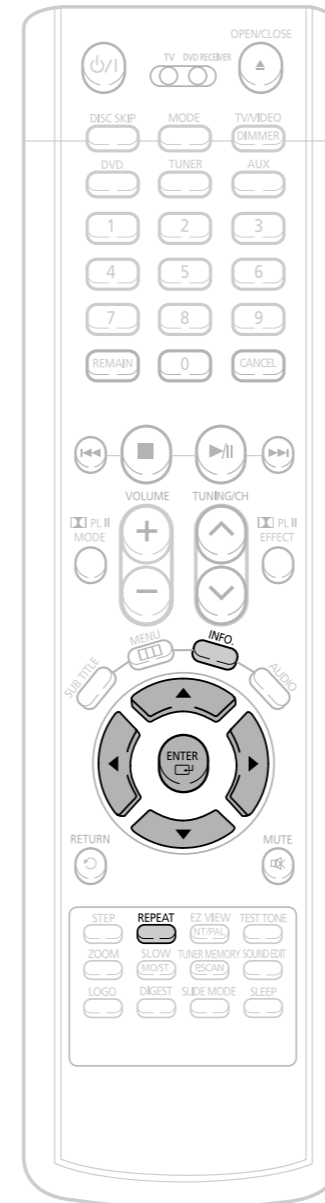

- To return to normal playback, press Cursor **▲**, **▼** buttons to select **↻ OFF**.

## Note

- The A-B Repeat function will not work on an MP3 or JPEG disc.



# Step Function DVD VCD

Press **STEP** button.

- The picture moves forward one frame each time the button is pressed during playback.

- Note**
- During fast playback of a CD or MP3-CD, sound is heard only at 2x speed, and not at 4x, 8x, and 32x speeds.
  - No sound is heard during slow or step motion playback.



# Angle Function DVD

This function allows you to view the same scene in different angles.

**1** Press **INFO** button.

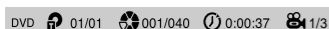

**2** Press Cursor **▶** button to move to **ANGLE ( & )** display.



**3** Press Cursor **▲, ▼** or numeric buttons to select the desired angle.

- Each time the button is pressed, the angle changes as follows:

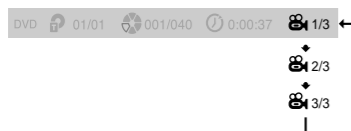

- Note**
- The Angle function works only with discs on which multiple angles have been recorded.

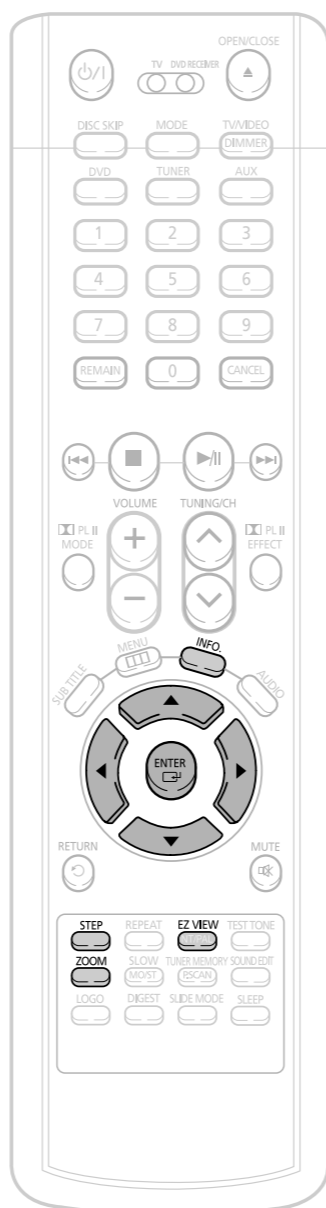

# Zoom (Screen Enlarge) Function DVD VCD

This function allows you to enlarge a particular area of the displayed image.

**1** Press **ZOOM** button.



**2** Press Cursor **▲, ▼, ◀, ▶** buttons to move to the area you want to enlarge.



**3** Press **ENTER** button.

- Each time the button is pressed, the zoom level changes as follows:

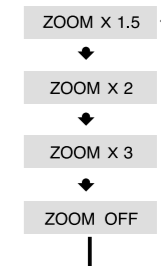

# EZ VIEW Function DVD

Press **EZ VIEW** button.

- Each time the button is pressed, the zoom function will switch between On and Off.
- When a movie is played in Widescreen format, black bars at the top and bottom of the TV screen can be removed by pressing the **EZ VIEW** button.



**Note**

- This function will not work if the DVD is recorded with multi-camera angle format.
- Black bars may not disappear because some DVD discs have a built-in horizontal to vertical ratio.

# Selecting Audio/Subtitle Language

## Audio Language Selection Function DVD

**1** Press **INFO** button twice.

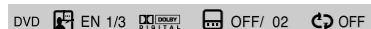

**2** Press Cursor **▲**, **▼** buttons or numeric buttons to select the desired audio language.

- Depending on the number of languages on a DVD disc, a different audio language (ENGLISH, SPANISH, FRENCH, etc.) is selected each time the button is pressed.

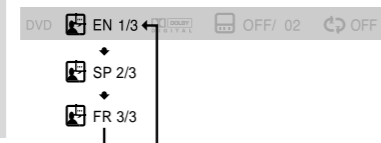

## Subtitle Language Selection Function DVD

**1** Press **INFO** button twice.



**2** Press Cursor **▶** button to move to **SUBTITLE** ( ) display.



**3** Press Cursor **▼** button or numeric buttons to select the desired subtitle.

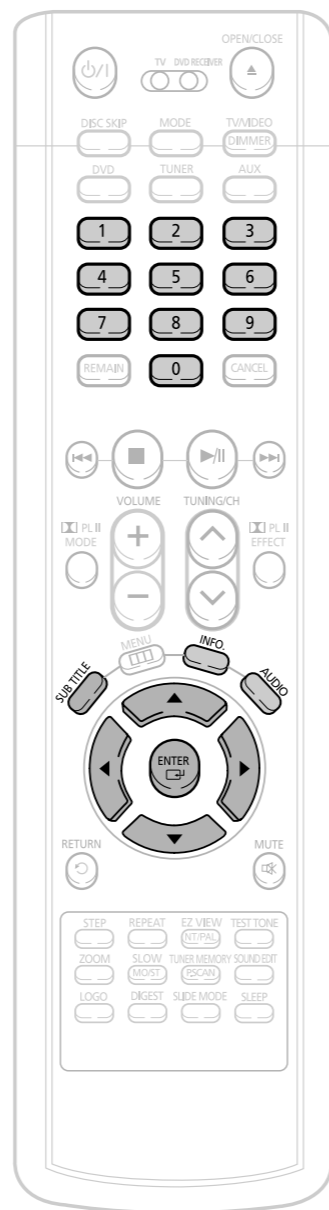
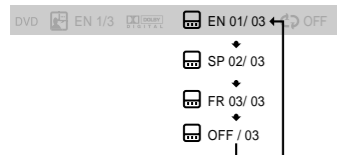

### Note

- You can use the SUBTITLE and AUDIO button on the remote control to select a subtitle language.
- Depending on the disc, the Subtitle and Audio Language functions may not work.

# Moving Directly to a Scene/Song

DVD VCD CD

**1** Press **INFO** button.



## Moving to a Title/Track

**2** Press Cursor **▲**, **▼** buttons or numeric buttons to select the desired title/track and then press **ENTER** button.



## Moving to a Chapter

**3** Press Cursor **◀**, **▶** buttons to move to Chapter ( ) display.



## Moving to a Chapter

**4** Press Cursor **▲**, **▼** buttons or numeric buttons to select the desired chapter and then press **ENTER** button.

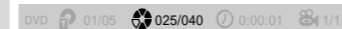

## Moving to a Specific Time

**5** Press Cursor **◀**, **▶** buttons to move to time display.



## Moving to a Specific Time

**6** Press the numeric buttons to select the desired time and then press **ENTER** button.



MP3 JPEG

Press the **numeric** buttons.

- The selected file will be played.
- An MP3 or JPEG disc cannot be moved in the disc information screen.
- When playing an MP3 or JPEG disc, you cannot use **▲**, **▼** to move to a folder. To move a folder, press **■** (Stop) and then press **▲**, **▼**.

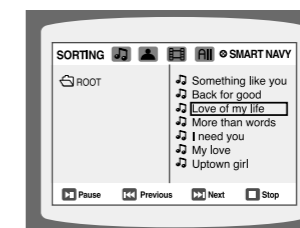

### Note

- You can press **◀◀▶▶** on the remote control to move directly to the desired title, chapter, or track.
- Depending on the disc, you may not be able to move to the selected title or time.

# Using Disc Menu DVD

You can use the menus for the audio language, subtitle language, profile, etc. DVD menu contents differ from disc to disc.

**1** In Stop mode, press **MENU** button.

- When playing a VCD (version 2.), this toggles between PBC ON and OFF.



**2** Press Cursor **▲,▼** buttons to move to 'DISC MENU' and then press **ENTER** button.

- When you select the disc menu that is not supported by the disc, the "This menu is not supported" message appears on the screen.



**3** Press Cursor **▲,▼** **◀,▶** buttons to select the desired item.

- Press **ENTER** button.

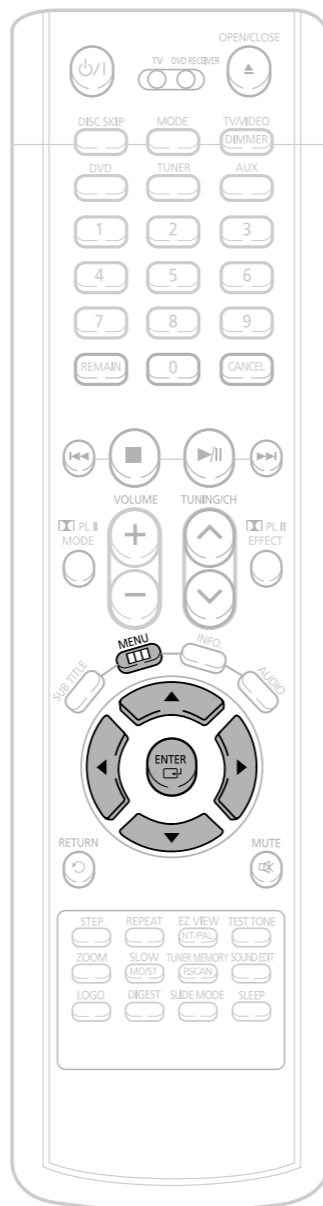

- Note** • Disc menu display may be different depending on the disc.

## PBC (Playback Control) Function

When playing a VCD (version 2.0), you can select and view various scenes according to the menu screen.

**PBC ON:** This VCD disc is version 2.0. The disc is played back according to the menu screen. Some functions may be disabled. When some functions are disabled, select "PBC OFF" to enable them.

**PBC OFF:** This VCD disc is version 1.1. The disc is played back in the same way as with a music CD.

# Using the Title Menu DVD

For DVDs containing multiple titles, you can view the title of each movie. Depending on the disc, the availability of this feature may vary.

**1** In Stop mode, press **MENU** button.



**2** Press Cursor **▲,▼** button to move to 'Title Menu'.



**3** Press **ENTER** button.

- The title menu appears.



Press **MENU** button to exit the setup screen.

- Note** • Title menu display may be different depending on the disc.

# Setting the Language

OSD (On-Screen Display) language is set to English by default.

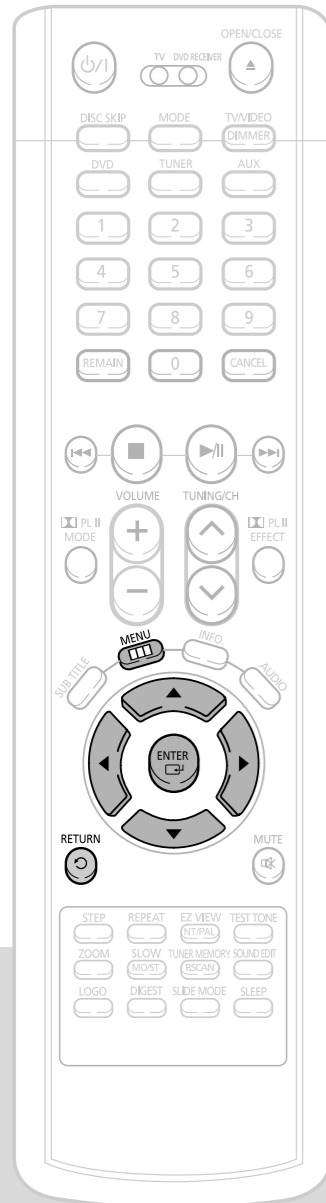

**1** In Stop mode, press **MENU** button.



**2** Press Cursor **▼** button to move to 'Setup' and then press **ENTER** button.



**3** Select 'Language' and then press **ENTER** button



**4** Press Cursor **▲, ▼** button to select 'OSD Language' and then press **ENTER** button.



**5** Press Cursor **▲, ▼** button to select the desired language and then press **ENTER** button.

- Once the setup is complete, if the language was set to English, OSD will be displayed in English.



Press **RETURN** button to return to the previous level.

Press **MENU** button to exit the setup screen.

**Note**

- To select another language, select OTHER and enter the language code of your country. (See page 64 for language codes)  
AUDIO, SUB TITLE and DISC MENU language can be selected.



Selecting the OSD Language



Selecting the Audio Language (recorded on the disc)



Selecting the Subtitle Language (recorded on the disc)



Selecting the Disc Menu Language (recorded on the disc)

- \* If the language you selected is not recorded on the disc, menu language will not change even if you set it to your desired language.

# Setting TV Screen type

Depending on your TV type (Wide Screen or conventional 4:3), you can select the TV's aspect ratio.

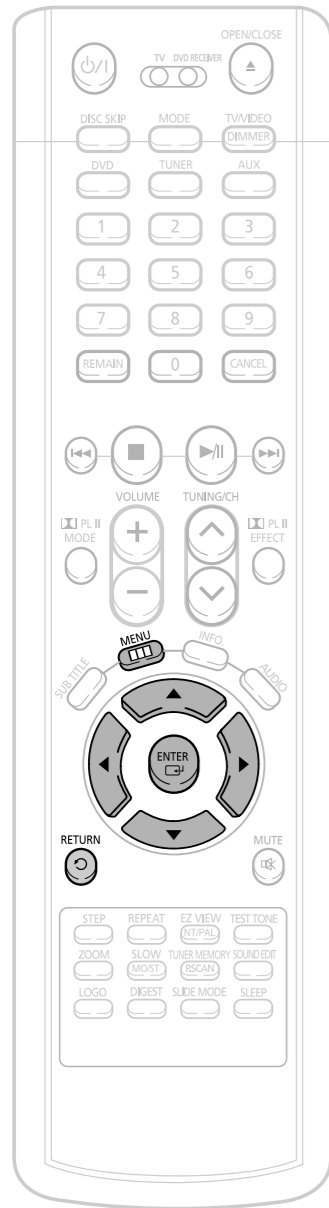

**1** In Stop mode, press **MENU** button.



**2** Press Cursor **▼** button to move to 'Setup' and then press **ENTER** button.



**3** Press Cursor **▼** button to move to 'TV DISPLAY' and then press **ENTER** button.

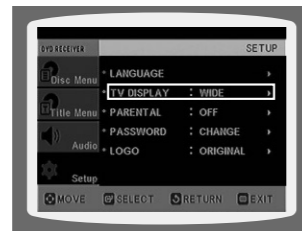

**4** Press Cursor **▲,▼** button to select the desired item and then press **ENTER** button.



• Once the setup is complete, you will be taken to the previous screen.

## Adjusting the TV Aspect Ratio (Screen Size)

The horizontal to vertical screen size ratio of conventional TVs is 4:3, while that of widescreen and high definition TVs is 16:9. This ratio is called the aspect ratio. When playing DVDs recorded in different screen sizes, you should adjust the aspect ratio to fit your TV or monitor.

• For a standard TV, select either "4:3LB" or "4:3PS" option according to personal preference. Select "16:9" if you have a widescreen TV.

**WIDE** : Select this to view a 16:9 picture in the full-screen mode on your widescreen TV.  
• You can enjoy the widescreen aspect.

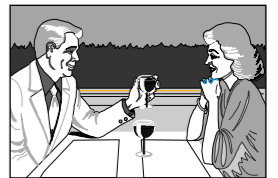

**4:3LB (4:3 Letterbox)** : Select this to play a 16:9 picture in the letter box mode on a conventional TV.  
• Black bars will appear at the top and bottom of the screen.



**4:3PS (4:3 Pan&Scan)** : Select this to play a 16:9 picture in the pan & scan mode on a conventional TV.  
• You can see the central portion of the screen only (with the sides of the 16:9 picture cut off).



**Note** • If a DVD is in the 4:3 ratio, you cannot view it in widescreen.  
• Since DVD discs are recorded in various image formats, they will look different depending on the software, the type of TV, and the TV aspect ratio setting.

Press **RETURN** button to return to the previous level.

Press **MENU** button to exit the setup screen.

SETUP

# Setting Parental Controls (Rating Level)

Use this to restrict playback of adult or violent DVDs you do not want children to view.

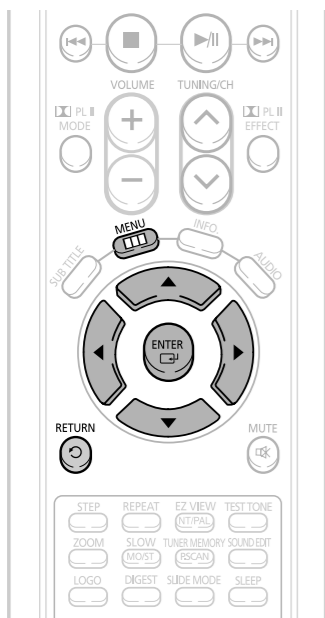

**1** In Stop mode, press **MENU** button.



**2** Press Cursor **▼** button to move to 'Setup' and then press **ENTER** button.

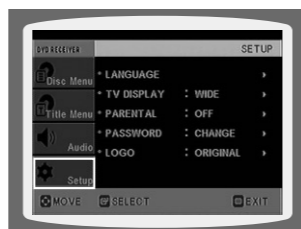

**3** Press Cursor **▼** button to move to 'PARENTAL' and then press **ENTER** button.

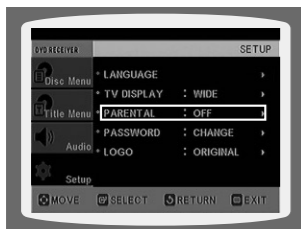

**4** Press Cursor **▲, ▼** button to select the desired rating level and then press **ENTER** button.

- If you have selected Level 6, you cannot view DVDs with Level 7 or higher.
- The higher the level, the closer the content is to violent or adult material.



**5** Enter the password and then press **ENTER** button.

- The password is set to "7890" by default.
- Once the setup is complete, you will be taken to the previous screen.

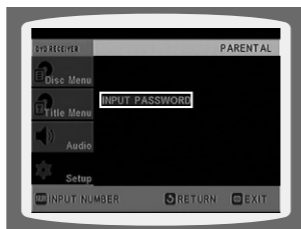

**Note** • This function works only if a DVD disc contains the rating level information.

Press **RETURN** button to return to the previous level.

Press **MENU** button to exit the setup screen.

# Setting the Password

You can set the password for the Parental (rating level) setting.

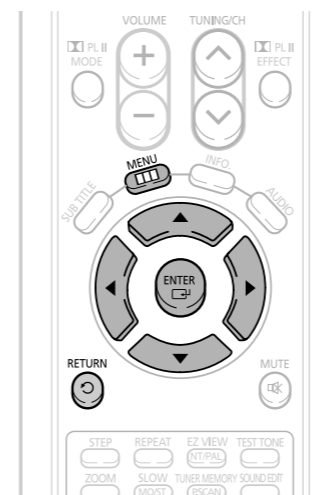

**1** Press **MENU** button.



**2** Press Cursor **▼** button to move to 'Setup' and then press **ENTER** button.



**3** Press Cursor **▼** button to move to 'PASSWORD' and then press **ENTER** button.



**4** Press **ENTER** button.



**5** Enter the password and then press **ENTER** button.

- Enter the old password, a new password, and confirm new password.
- The setting is complete.

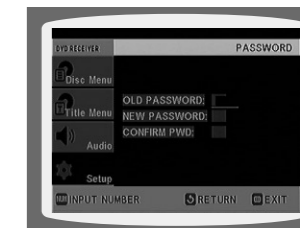

**Note** • The password is set to "7890" by default.

**If you have forgotten the rating level password, do the following:**

- While the player is in the no disc mode, hold the main unit's button for longer than 5 seconds. "RESET" appears on the display and all settings will return to the default values.
- Press the POWER button.

Using the RESET function will erase all stored settings. Do not use this unless necessary.

# Setting the Wallpaper

JPEG DVD VCD

While watching a DVD, VCD or JPEG CD, you can set the image you like as background wallpaper.

## Setting the Wallpaper

**1** During playback, press **PLAY/PAUSE** button when an image you like appears.



**2** Press **LOGO** button.

- "COPY LOGO DATA" will be displayed on the TV screen.



**3** The power will turn off and then back on.

- The selected wallpaper will be displayed.
- You can select up to 3 wallpaper settings.

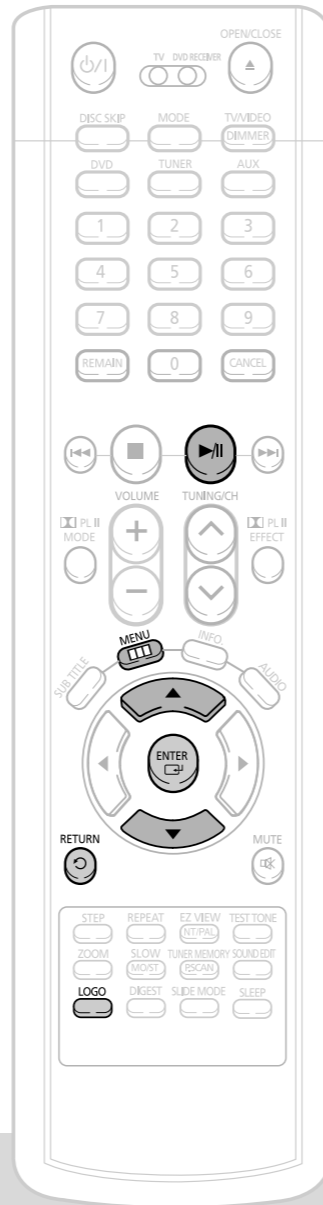

## To select one of the 3 wallpaper settings you've made

**1** In Stop mode, press **MENU** button.



**2** Press Cursor **▼** button to move to 'Setup' and then press **ENTER** button.



**3** Press Cursor **▼** button to move to 'LOGO' and then press **ENTER** button.



**4** Press **▼** to select the desired 'USER', and then press **ENTER**.



**5** Press **MENU** button to exit the setup screen.



Select this to set the Samsung Logo image as your wallpaper.



Select this to set the desired image as your wallpaper.

Press **RETURN** button to return to the previous level.

Press **MENU** button to exit the setup screen.

# Setting the Speaker Mode

Signal outputs and frequency responses from the speakers will automatically be adjusted according to your speaker configuration and whether certain speakers are used or not.

**1** In Stop mode, press **MENU** button.



**2** Press Cursor **▼** button to move to 'Audio' and then press **ENTER** button.



**3** In the Speaker Setup, press the **ENTER** button again.

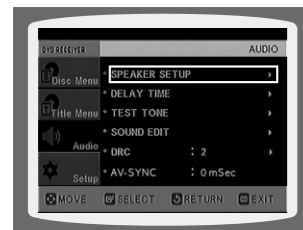

**4** Press Cursor **▲, ▼, ◀, ▶** buttons to move to the desired speaker and then press **ENTER** button.



- For C, LS, and RS, each time the button is pressed, the mode switches alternately as follows: SMALL → NONE.
- For L and R, the mode is set to SMALL.

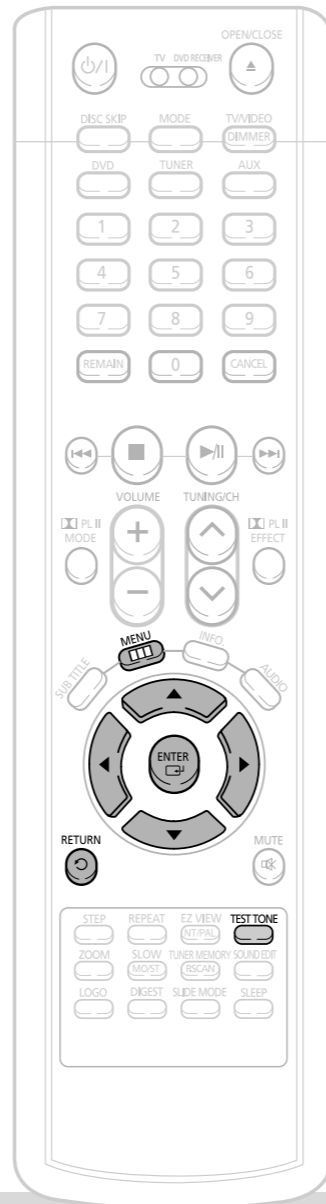

**SMALL** : Select this when using the speakers.

**NONE** : Select this when no speakers are connected.

## Note

- Depending on PRO LOGIC and STEREO settings, the speaker mode may vary (see page 53).

# Setting the Test Tone

Use the Test Tone feature to check the speaker connections.

**1** In Stop or no disc mode, press **MENU** button.



**2** Press Cursor **▼** button to move to 'Audio' and then press **ENTER** button.



**3** Press Cursor **▼** button to move to 'TEST TONE' and then press **ENTER** button.

- The test tone will be sent to L → C → R → RS → LS → SW in order. If the ENTER button is pressed again at this time, the test tone will stop.

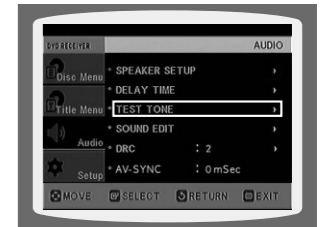

Press **RETURN** button to return to the previous level.

Press **MENU** button to exit the setup screen.

Alternate method: press the **TEST TONE** button on the remote.

Press **TEST TONE** button.

- Test tone will be produced as follows: When playing a DVD or CD, this will work only in Stop mode.
- Use this function to check that each speaker is correctly connected and that there is no problem.

To end the test tone, press **TEST TONE** button again.

L: Front Speaker (L)    C: Center Speaker    SW: Subwoofer  
R: Front Speaker (R)    LS: Rear Speaker (L)    RS: Rear Speaker (R)

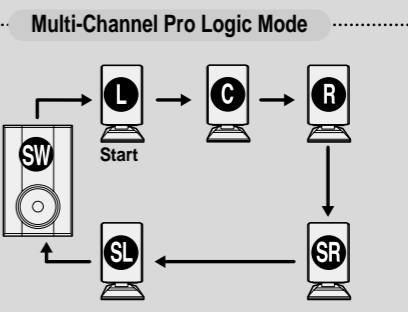



# Setting the Delay Time

If the speakers cannot be placed at equal distances from the listening position, you can adjust the delay time of the audio signals from the center and rear speakers.

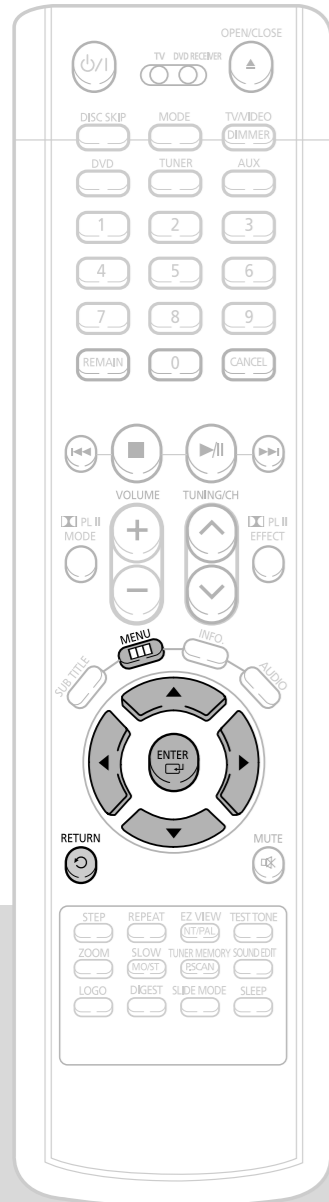

**1** In Stop mode, press **MENU** button.



**2** Press Cursor **▼** button to move to 'Audio' and then press **ENTER** button.



**3** Press Cursor **▼** button to move to 'DELAY TIME' and then press **ENTER** button.

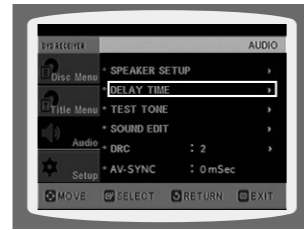

**4** Press Cursor **▲, ▼, ◀, ▶** buttons to move to the desired speaker and then press **ENTER** button.



**5** Press Cursor **◀, ▶** to set the Delay time.



- You can set the delay time for C between 00 and 05mSEC and for LS and RS between 00 and 15mSEC.

## Setting up the Speaker Delay Time

When 5.1CH Surround Sound is played, you can enjoy the best sound if the distance between you and each speaker is the same. Since the sounds arrive at the listening position at different times depending on the placement of speakers, you can adjust this difference by adding a delay effect to the sound of the Center Speaker and Surround Speakers.

**Note**

- With  $\square$ PL (Dolby Pro Logic II), the delay time may be different for each mode.
- With AC-3 the delay time can be set between 00 and 15mSEC.
- The Center channel is only adjustable on 5.1 channel discs.

### • Setting CENTER SPEAKER

If the distance of  $D_c$  is equal to or longer than the distance of  $D_f$  in the figure, set the mode as 0ms. Otherwise, change the setting according to the table.

Distance between $D_f$ and $D_c$	Delay Time
0.00 m	0 ms
0.34 m	1 ms
0.68 m	2 ms
1.02 m	3 ms
1.36 m	4 ms
1.70 m	5 ms

### • Setting REAR (SURROUND) SPEAKERS

If the distance of  $D_f$  is equal to the distance of  $D_s$  in the figure, set the mode as 0ms. Otherwise, change the setting according to the table.

Distance between $D_f$ and $D_s$	Delay Time
0.00 m	0 ms
1.02 m	3 ms
2.04 m	6 ms
3.06 m	9 ms
4.08 m	12 ms
5.10 m	15 ms

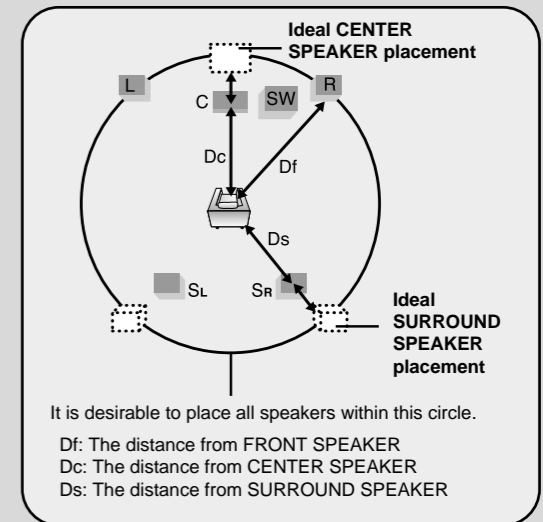

# Setting the Audio

You can adjust the balance and level for each speaker.

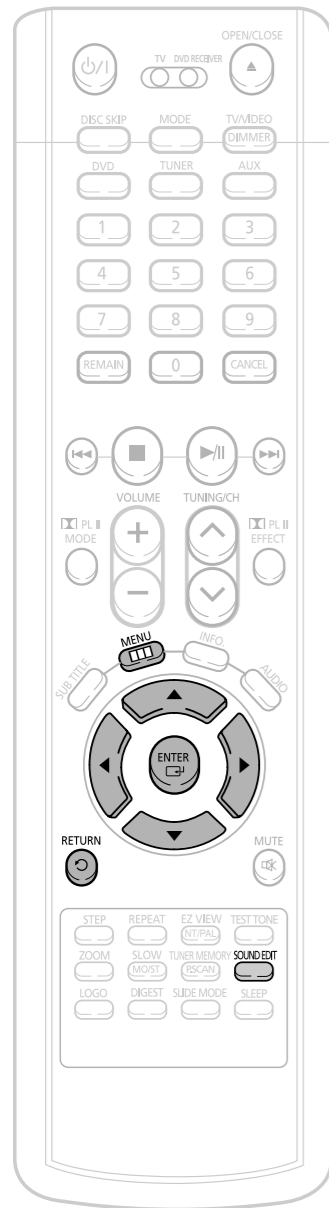

## Method 1 When adjusting the audio quality using the setup screen

- 1 In Stop mode, press **MENU** button.
- 2 Press Cursor **▼** button to move to 'Audio' and then press **ENTER** button.
- 3 Press Cursor **▼** button to move to 'SOUND EDIT' and then press **ENTER** button.
- 4 Press Cursor **▲, ▼** buttons to select and adjust the desired item. Press the **◀, ▶** buttons to adjust the settings.

## Method 2 When manually adjusting with the SOUND EDIT button

### Adjusting Front Speaker Balance

- 1 Press **SOUND EDIT** button and then press Cursor **◀, ▶**.

00F00

### Adjusting Rear Speaker Balance

- 2 Press **SOUND EDIT** button and then press Cursor **◀, ▶**.

00R-1

### Adjusting Center Speaker Level

- 3 Press **SOUND EDIT** button and then press Cursor **◀, ▶**.

[ 0

### Adjusting Rear Speaker Level

- 4 Press **SOUND EDIT** button and then press Cursor **◀, ▶**.

R -2

### Adjusting Subwoofer Speaker Level

- 5 Press **SOUND EDIT** button and then press Cursor **◀, ▶**.

SW 0

- Press **RETURN** button to return to the previous level.
- Press **MENU** button to exit the setup screen.

**Note** • The adjustments will appear on the main unit's display, not on your TV screen.

### Adjusting Front/Rear Speaker Balance

- You can select between 00 and -06 and OFF.
- The volume decreases as you move closer to -6.

### Adjusting Center/Rear/Subwoofer Speaker Level

- The volume level can be adjusted in steps from +6dB to -6dB.
- The sound gets louder as you move closer to +6dB and quieter as you get closer to -6dB.

# Setting the DRC (Dynamic Range Compression)

You can use this function to enjoy Dolby Digital sound when watching movies at low volume at night.

**1** In Stop mode, press **MENU** button.



**2** Press Cursor **▼** button to move to 'Audio' and then press **ENTER** button.



**3** Press Cursor **▼** button to move to 'DRC' and then press **ENTER** button.



**4** Press Cursor **▲, ▼** to adjust the 'DRC'.

- When the Cursor **▲** button is pressed, the effect is greater, and when the Cursor **▼** button is pressed, the effect is smaller.

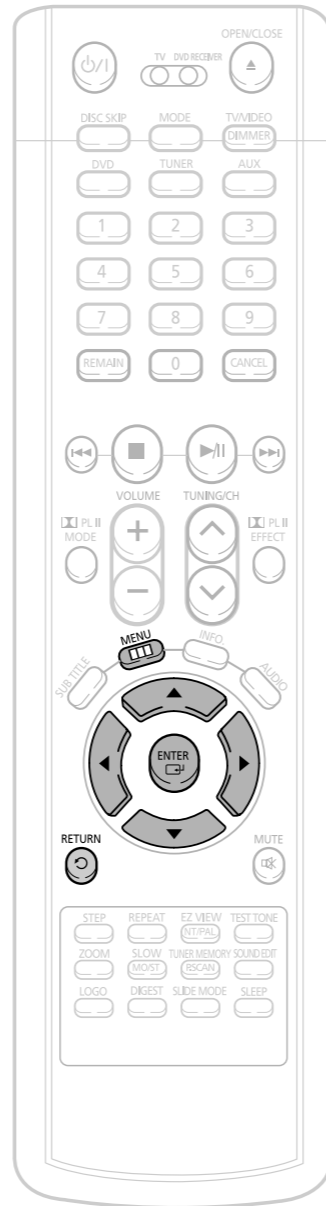

# AV SYNC Setup

Video may look slower than the audio if it is connected to a digital TV. If this occurs, adjust the audio delay time to match the video.

**1** Press the **MENU** button.

- Setup menu appears.



**2** Press Cursor **▲, ▼** buttons to move to 'Audio' and then press **ENTER** button.

- 'Audio' menu appears.



**3** Press Cursor **▲, ▼** buttons to move to 'AV-SYNC' and then press **ENTER** button.

- AV-SYNC screen appears.

**4** Press Cursor **▲, ▼** buttons to select the AV-SYNC Delay Time and then press the **ENTER** button.

- You can set the audio delay time between 0 ms and 300 ms. Set it to the optimal status.

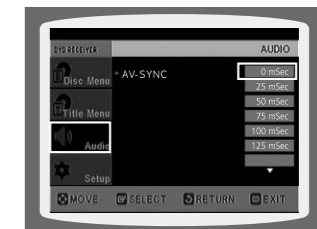

Press **RETURN** button to return to the previous level.

Press **MENU** button to exit the setup screen.

Press **RETURN** button to return to the previous level.

Press **MENU** button to exit the setup screen.

# Dolby Pro Logic II Mode

You can select the desired Dolby Pro Logic II audio mode.

Press **PL II MODE** button.

- Each time the button is pressed, the mode changes as follows.

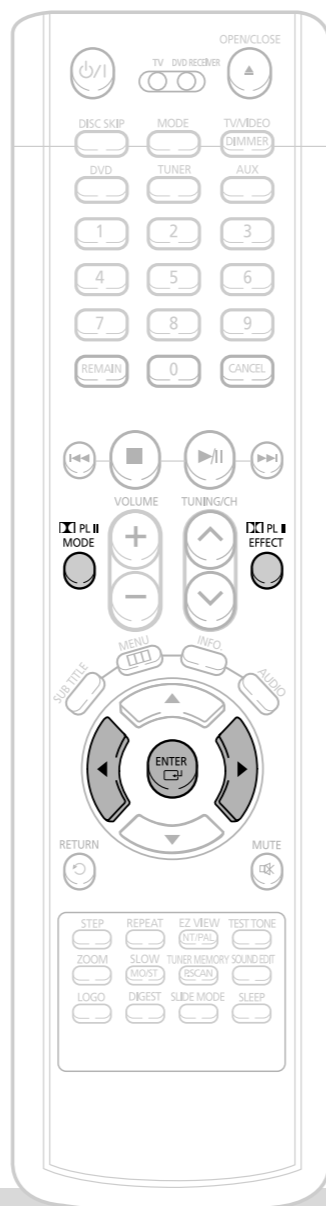
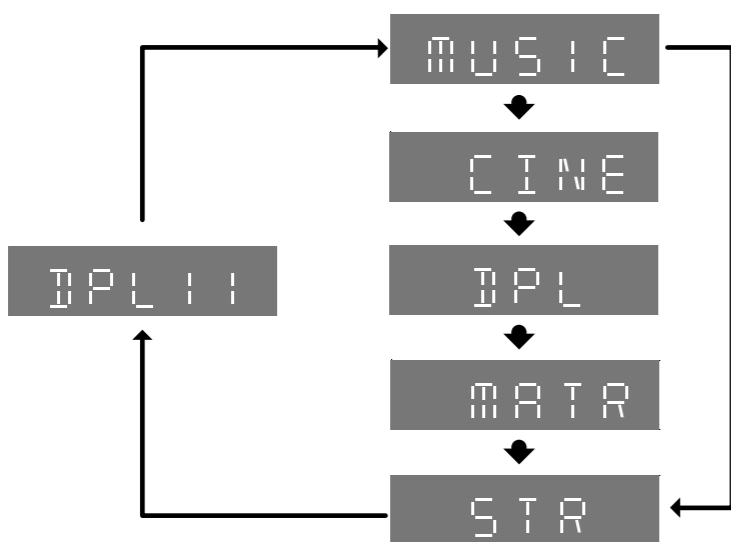

## Note

- When selecting Pro Logic II mode, connect your external device to the AUDIO INPUT jacks (L and R) on the player. If you connect to only one of the inputs (L or R), you cannot listen to surround sound.

## PRO LOGIC II

- **MUSIC:** When listening to music, you can experience sound effects as if you are listening to the actual performance.
  - **CINEMA:** Adds realism to the movie soundtrack.
  - **PRO LOGIC:** You will experience a realistic multi-channel effect, as if using five speakers, while using just the front left and right speakers.
  - **MATRIX:** You will hear 5.1 channel surround sound.
- STEREO:** Select this to listen to sound from the front left and right speakers and the subwoofer only.

# Dolby Pro Logic II Effect

This function works only in Dolby Pro Logic MUSIC mode.

**1** Press **PL II MODE** button to select 'MUSIC' mode.



**2** Press **PL II EFFECT** button to select Panorama, then press Cursor , buttons to select the desired effect setting.

- You can select either 0 or 1.
- This mode extends the front stereo image to include the surround speakers for an exciting "wraparound" effect with side wall imaging.



**3** Press **PL II EFFECT** button to select C-Width, then press Cursor , buttons to select the desired effect setting.

- You can select between 0 and 7.
- This sets the width of the center image. The higher the setting, the less sound comes from the center speaker.



**4** Press **PL II EFFECT** button to select Dimension, then press the Cursor , buttons to select the desired setting.

- You can select between 0 and 6.
- Incrementally adjusts the sound field (DSP) from the front or rear.



## Note

- When playing a DVD disc encoded with two or more channels, multi-channel mode will be selected automatically and PL II (Dolby Pro Logic II) button does not work.

# Listening to Radio

## Remote Control Unit

**1** Press **TUNER** button.

- FM will appear in the display.

**2** Tune in to the desired station.

**Automatic Tuning 1** When **◀▶** is pressed, a preset broadcast station is selected.

**Automatic Tuning 2** Press and hold **TUNING/CH** button to automatically search for active broadcasting stations.

**Manual Tuning** Briefly press **TUNING/CH** button to increase or decrease the frequency incrementally.

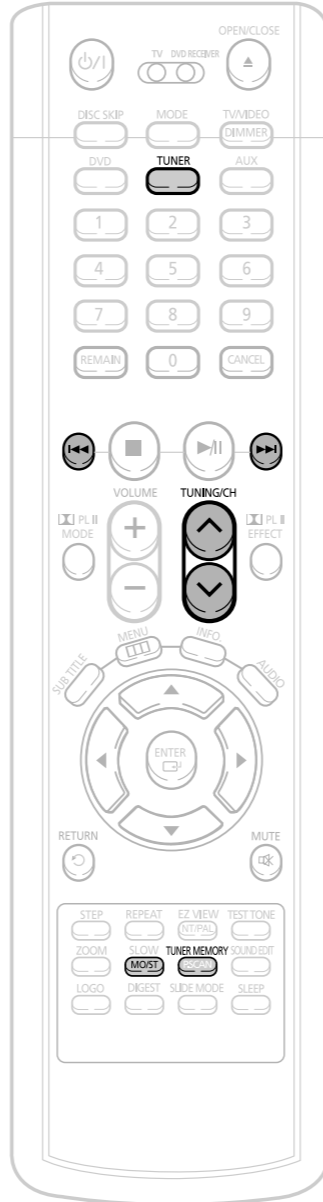

## Main Unit

**1** Press the **Function** button to select the FM.

**2** Select a broadcast station.

**Automatic Tuning 1** Press the **STOP** (■) button to select **PRESET** and then press **◀▶** button to select the preset station.

**Automatic Tuning 2** Press the **STOP** (■) button to select **MANUAL** and then press and hold **◀▶** button to automatically search the band.

**Manual Tuning** Press **STOP** (■) to select **MANUAL** and then briefly press **◀▶** to tune in to a lower or higher frequency.

# Presetting Stations

You can store up to:

- ◆ 15 FM stations

- FM ..... Frequency Modulation

Example: Presetting FM 89.1 in the memory

**1** Press the **TUNER** button.

FM

**2** Press **TUNING/CH** to select "89.10".

- Refer to Step 2 on page 55 to automatically or manually tune in to a station.

89.10

**3** Press the **TUNER MEMORY** button.

- "FM 01" flashes in the display.

FM 01

**4** Press **◀▶** to select preset number.

- You can select between 1 and 15.

FM 01

**5** Press the **TUNER MEMORY** button again.

89.10

**6** To preset another station, repeat steps 2 to 5.

**Note**

- If you save more than 15 stations, the oldest station previously saved is removed and a new station is stored in its place.

Press **MO/ST** button to listen in Mono/Stereo.

- Each time the button is pressed, the sound switches between "STEREO" and "MONO".
- In a poor reception area, select MONO for a clear, interference-free broadcast.

To tune in to a preset station, press **◀▶** on the remote control to select a channel.

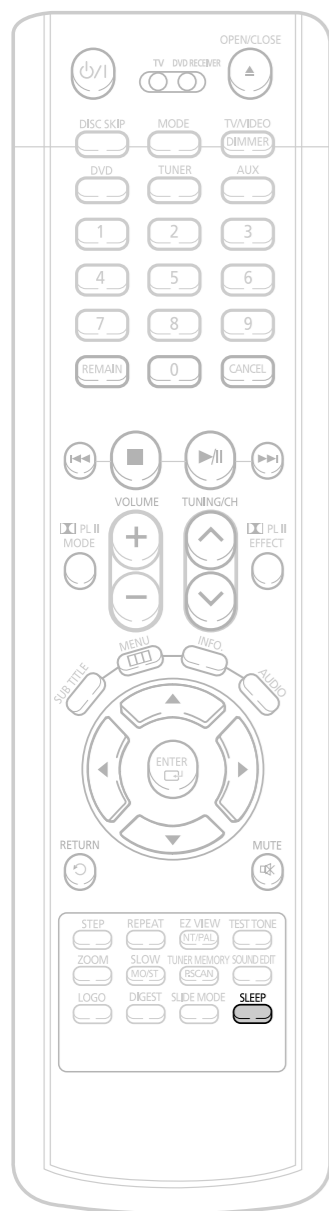

## Sleep Timer Function

You can set the time that the Home Theater will shut itself off.

Press **SLEEP** button.

- "SLEEP" will be displayed. Each time the button is pressed, the preset time changes as follows: 10 → 20 → 30 → 60 → 90 → 120 → 150 → OFF.



To confirm the sleep timer setting, press **SLEEP** button.

- The remaining time before the Home Theater will shut itself off is displayed.
- Pressing the button again changes the sleep time from what you have set earlier.

To cancel the sleep timer, press **SLEEP** button until OFF appears on the display.

## Adjusting Display Brightness

You can adjust the brightness of the display on the main unit so it won't interfere with your movie viewing.

Press **DIMMER** button.

- Each time the button is pressed, the brightness changes as follows: DARK → BRIGHT.

## Mute Function

This is useful when answering a doorbell or telephone call.

Press **MUTE** button.

- 'MUTE' flash in the display.
- To switch the sound back on (at the same volume as before), press **MUTE** again or the **VOLUME** buttons.

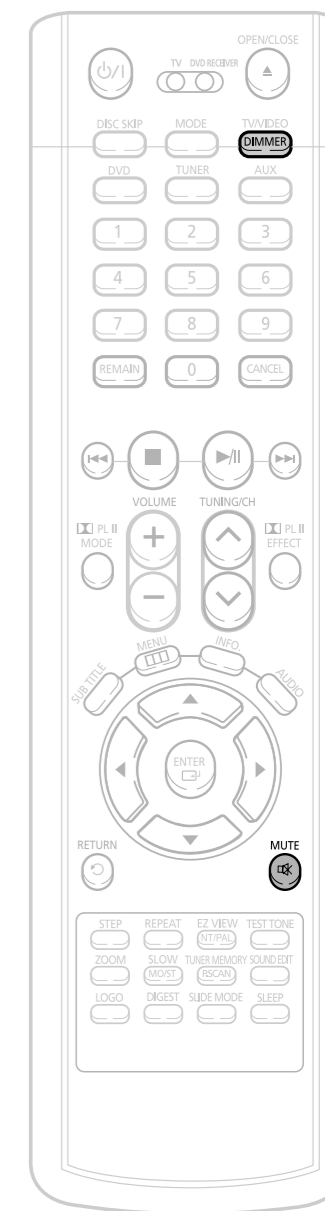

# Operating a TV with the Remote Control

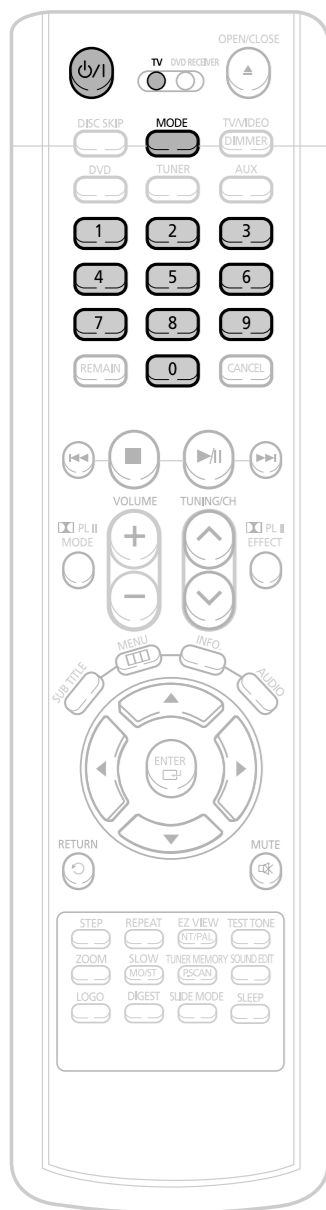

## When operating a TV with the remote control

**1** Press the **MODE** button to make the TV indicator on the remote control flash.



**2** Press **POWER** button to turn on the TV.

**3** Point the remote control toward the TV.

**4** While holding down **POWER**, enter the code corresponding to your brand of TV.

- If the code matches the TV's code, the TV will be turned off.
- If there is more than one code listed for your TV in the table, enter one at a time to determine which code works.

**Example: For a Samsung TV**  
While holding down **POWER**, use the number buttons to enter 00, 01, 02, 03, 04, and 05.

**5** Point the remote control toward the TV and press **POWER**. If the TV turns off or on, the setting is complete.

- You can use the TV **POWER**, **VOLUME**, **CHANNEL**, and **Numeric** buttons (0~9).

**Note**

- The remote control may not work on some brands of TVs. Also, depending on your brand of TV, some operations may not be possible.
- If you do not set the remote control with the code for your brand of TV, the remote control will work on a Samsung TV by default.



## TV Brand Code List

No.	Brand	Code	No.	Brand	Code
1	SAMSUNG	00(Initial Value), 01, 02, 03, 04, 05, 73	30	BRANDT	41
2	ANAM	06~11, 59	31	FERGUSON	41
3	DAEWOO	12~18, 20, 21	32	PIONEER	41, 48, 74
4	LG	05, 20, 21, 22, 53	33	TELEAVA	41
5	HITACHI	23, 40, 41, 49	34	FINLUX	05, 42, 47
6	JVC	24, 55	35	FISHER	31
7	SHARP	27, 33, 34, 35, 54	36	AKAI	31
8	SONY	27, 36	37	YOKO	05
9	TOSHIBA	27, 37, 42, 43, 44, 46	38	PHONOLA	05, 45, 47
10	SANYO	27, 30, 31, 32	39	RADIOLA	05, 45
11	mitsubishi	05, 27, 28	40	SCHNEIDER	05
12	MATSUSHITA	09, 26	41	NEWSAN	58
13	TELEFUNKEN	41, 49, 51, 57	42	CONTINENTAL EDISON	49
14	RCA	29, 61	43	SALORA	48
15	PANASONIC	07, 09, 26, 48, 49, 50	44	SELECO	48
16	SABA	40, 41, 47, 48, 49	45	NOKIA	48
17	PHILIPS	05, 45, 47, 64, 65, 66, 67, 68, 69	46	REX	48
18	GRUNDIG	39, 42, 46, 70, 71, 72	47	MIVAR	46
19	ZENITH	38	48	IMPERIAL	46
20	MIVAL	52	49	CGE	46
21	NOBLEX	56	50	BANG & OLUFSEN	47
22	EMERSON	19	51	BRIONVEGA	47
23	MAGNAVOX	25	52	FORMENTI	47
24	LOEWE	05, 60	53	METZ	47
25	THOMSON	40, 41, 49, 62, 63	54	WEGA	47
26	NORDMENDE	40, 41, 49	55	RADIOMARELLI	47
27	LOEWE OPTA	36, 47, 05	56	SINGER	47
28	BLAUPUNKT	39	57	SINUDYNE	47
29	SIEMENS	39			

# Before Calling for Service

Refer to the chart below when this unit does not function properly. If the problem you are experiencing is not listed below or if the instruction below does not help, turn off the unit, disconnect the power cord, and contact the nearest authorized dealer or Samsung Electronics Service Center.

Symptom	Check/Remedy
<b>Disc tray does not open.</b>	<ul style="list-style-type: none"> <li>• Is the power cord plugged securely into the outlet?</li> <li>• Turn off the power and then turn it back on.</li> </ul>
<b>Playback does not start.</b>	<ul style="list-style-type: none"> <li>• Check the region number of the DVD. DVD discs purchased from abroad may not be playable.</li> <li>• CD-ROMs and DVD-ROMs cannot be played on this Home Theater.</li> <li>• Make sure that the rating level is correct.</li> </ul>
<b>Playback does not start immediately when the Play/Pause button is pressed.</b>	<ul style="list-style-type: none"> <li>• Are you using a deformed disc or a disc with scratches on the surface?</li> <li>• Wipe the disc clean.</li> </ul>
<b>Sound is not produced.</b>	<ul style="list-style-type: none"> <li>• No sound is heard during fast playback, slow playback, and step motion playback.</li> <li>• Are the speakers connected properly? Is the speaker setup correctly customized?</li> <li>• Is the disc severely damaged?</li> </ul>
<b>Sound can be heard only from a few speakers and not all six.</b>	<ul style="list-style-type: none"> <li>• When listening to a CD or radio, sound is output to the front speakers (L/R) only. Select "PRO LOGIC II" by pressing  PL II (Dolby Pro Logic II) on the remote control to use all six speakers.</li> <li>• Make sure that the DVD disc is 5.1-CH compatible.</li> <li>• If you set C, SL, and SR to NONE in the speaker mode in the audio setup of the setup screen, no sound is heard from the center speaker and the front left and right speakers. Set C, SL, and SR to SMALL.</li> </ul>
<b>Picture does not appear, sound is not produced, or the disc tray opens 2 to 5 seconds later.</b>	<ul style="list-style-type: none"> <li>• Was the Home Theater suddenly moved from a cold place to a warm one? When condensation forms inside the player, remove the disc and let the player stand for 1 or 2 hours with the power on. (You can use the player again after condensation disappears.)</li> </ul>
<b>Dolby Digital 5.1 CH Surround Sound is not produced.</b>	<ul style="list-style-type: none"> <li>• Is there "Dolby Digital 5.1 CH" mark on the disc? Dolby Digital 5.1 CH Surround Sound is produced only if the disc is recorded with 5.1 channel sound.</li> <li>• Is the audio language correctly set to DOLBY DIGITAL 5.1-CH in the information display?</li> </ul>

Symptom	Check/Remedy
<ul style="list-style-type: none"> <li>• <b>Disc is rotating but no picture is produced.</b></li> <li>• <b>Picture quality is poor and picture is shaking.</b></li> </ul>	<ul style="list-style-type: none"> <li>• Is the TV power on?</li> <li>• Are the video cables connected properly?</li> <li>• Is the disc dirty or damaged?</li> <li>• A poorly manufactured disc may not be playable.</li> </ul>
<b>The remote control does not work.</b>	<ul style="list-style-type: none"> <li>• Is the remote control being operated within its operation range of angle and distance?</li> <li>• Are the batteries exhausted?</li> </ul>
<b>Audio language and subtitles do not work.</b>	<ul style="list-style-type: none"> <li>• Audio language and subtitles will not work for DVDs not containing them. And depending on the disc, they may work differently.</li> </ul>
<b>Menu screen does not appear even when the menu function is selected.</b>	<ul style="list-style-type: none"> <li>• Are you using a disc that does not contain menus?</li> </ul>
<b>Aspect ratio cannot be changed.</b>	<ul style="list-style-type: none"> <li>• You can play 16:9 DVDs in 16:9 WIDE mode, 4:3 LETTER BOX mode, or 4:3 PAN SCAN mode, but 4:3 DVDs can be seen in 4:3 ratio only. Refer to the DVD disc jacket and then select the appropriate function.</li> </ul>
<b>Can't receive radio broadcast.</b>	<ul style="list-style-type: none"> <li>• Is the antenna connected properly?</li> <li>• If the antenna's input signal is weak, install an external FM antenna in an area with good reception.</li> </ul>
<ul style="list-style-type: none"> <li>• <b>The main unit is not working. (Example: The power goes out or strange noise is heard.)</b></li> <li>• <b>The Home Theater is not working normally.</b></li> </ul>	<ul style="list-style-type: none"> <li>• Turn off the power and hold the  button on the main unit for longer than 5 seconds.</li> </ul> <p>Using the RESET function will erase all stored settings. Do not use this unless necessary.</p>
<b>The password for rating level has been forgotten.</b>	<ul style="list-style-type: none"> <li>• While "NO DISC" message appears on the display of main unit, hold the main unit's  button for longer than 5 seconds. "RESET" appears on the display and all settings will return to the default values.</li> <li>• Press the POWER button.</li> </ul> <p><b>Using the RESET function will erase all stored settings. Do not use this unless necessary.</b></p>



# Cautions on Handling and Storing Discs

Small scratches on the disc may reduce sound and picture quality or cause skipping. Be especially careful not to scratch discs when handling them.

## ● Handling discs

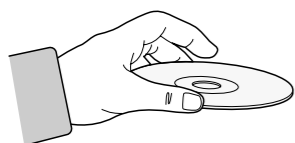

**Do not touch the playback side of the disc. Hold the disc by the edges so that fingerprints will not get on the surface.**

**Do not stick paper or tape on the disc.**

## ● Disc Storage

**Do not keep in direct sunlight**

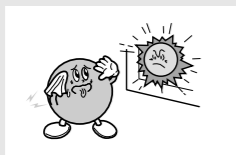

**Keep in a cool ventilated area**

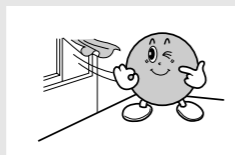

**Keep in a clean Protection jacket. Store vertically.**

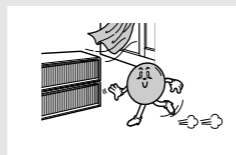

### Caution

- Do not allow the discs to become contaminated with dirt.
- Do not load cracked or scratched discs.

## ● Handling and Storing Discs



**When you get fingerprints or dirt on the disc, clean it with a mild detergent diluted in water and wipe with a soft cloth.**

- When cleaning, wipe gently from the inside to the outside of the disc.

### Note

- Condensation may form if warm air comes into contact with cold parts inside the player. When condensation forms inside the player, the player may not operate correctly. If this occurs, remove the disc and let the player stand for 1 or 2 hours with the power on.

# Language Code List

Enter the appropriate code number for the initial settings "Disc Audio", "Disc Subtitle" and/or "Disc Menu" (See page 37).

Code	Language	Code	Language	Code	Language	Code	Language
1027	Afar	1181	Frisian	1334	Latvian, Lettish	1506	Slovenian
1028	Abkhazian	1183	Irish	1345	Malagasy	1507	Samoan
1032	Afrikaans	1186	Scots Gaelic	1347	Maori	1508	Shona
1039	Amharic	1194	Galician	1349	Macedonian	1509	Somali
1044	Arabic	1196	Guarani	1350	Malayalam	1511	Albanian
1045	Assamese	1203	Gujarati	1352	Mongolian	1512	Serbian
1051	Aymara	1209	Hausa	1353	Moldavian	1513	Siswati
1052	Azerbaijani	1217	Hindi	1356	Marathi	1514	Sesotho
1053	Bashkir	1226	Croatian	1357	Malay	1515	Sundanese
1057	Byelorussian	1229	Hungarian	1358	Maltese	1516	Swedish
1059	Bulgarian	1233	Armenian	1363	Burmese	1517	Swahili
1060	Bihari	1235	Interlingua	1365	Nauru	1521	Tamil
1069	Bislama	1239	Interlingue	1369	Nepali	1525	Tegulu
1066	Bengali; Bangla	1245	Inupiak	1376	Dutch	1527	Tajik
1067	Tibetan	1248	Indonesian	1379	Norwegian	1528	Thai
1070	Breton	1253	Icelandic	1393	Occitan	1529	Tigrinya
1079	Catalan	1254	Italian	1403	(Afan) Oromo	1531	Turkmen
1093	Corsican	1257	Hebrew	1408	Oriya	1532	Tagalog
1097	Czech	1261	Japanese	1417	Punjabi	1534	Setswana
1103	Welsh	1269	Yiddish	1428	Polish	1535	Tonga
1105	Danish	1283	Javanese	1435	Pashto, Pushto	1538	Turkish
1109	German	1287	Georgian	1436	Portuguese	1539	Tsonga
1130	Bhutani	1297	Kazakh	1463	Quechua	1540	Tatar
1142	Greek	1298	Greenlandic	1481	Rhaeto-Romance	1543	Twi
1144	English	1299	Cambodian	1482	Kirundi	1557	Ukrainian
1145	Esperanto	1300	Kannada	1483	Romanian	1564	Urdu
1149	Spanish	1301	Korean	1489	Russian	1572	Uzbek
1150	Estonian	1305	Kashmiri	1491	Kinyarwanda	1581	Vietnamese
1151	Basque	1307	Kurdish	1495	Sanskrit	1587	Volapuk
1157	Persian	1311	Kirghiz	1498	Sindhi	1613	Wolof
1165	Finnish	1313	Latin	1501	Sangro	1632	Xhosa
1166	Fiji	1326	Lingala	1502	Serbo-Croatian	1665	Yoruba
1171	Faeroese	1327	Laothian	1503	Singhalese	1684	Chinese
1174	French	1332	Lithuanian	1505	Slovak	1697	Zulu

# Specifications

GENERAL	Power Consumption	85W	
	Weight	4.9Kg	
	Dimensions (W x H x D)	430 x 76 x 430 mm	
	Operating Temperature Range	+5°C~+35°C	
	Operating Humidity Range	10% ~ 75%	
TUNER	Usable Sensitivity	10dB	
	S/N Ratio	60dB	
	Distortion	0.5%	
VIDEO	Composite Video	1.0Vp-p(75Ω load)	
	Component Video	Y:1.0Vp-p(75Ω load)	
		Pr:0.70Vp-p(75Ω load)	
		Pb:0.70Vp-p(75Ω load)	
AMPLIFIER	Front speaker output	100W x 2(4Ω)	
	Center speaker output	100W(4Ω)	
	Rear speaker output	100W x 2(4Ω)	
	Subwoofer speaker output	100W(4Ω)	
	Frequency range	20Hz~20KHz	
	S/N Ratio	75dB	
	Channel separation	50dB	
	Input sensitivity	(AUX)400mV	
SPEAKER	Speaker system	5.1ch speaker system	
		Front/Center/Rear speaker	Subwoofer speaker
	Impedance	4Ω x 5	4Ω
	Frequency range	145Hz~20KHz	35Hz~140Hz
	Output sound pressure level	85dB/W/M	85dB/W/M
	Rated input	100W	100W
	Maximum input	200W	200W
	Dimensions (W x H x D)	98 x 98 x 100 mm	145 x 320 x 340 mm
Weights	0.5 Kg	3.6 Kg	

# Memo